

Industrial panel with flat outer sheet
 Available in heights 488, 610 and 732mm.
 Inner sheet : ribbed, smooth, RAL 9002.

PANEL HF

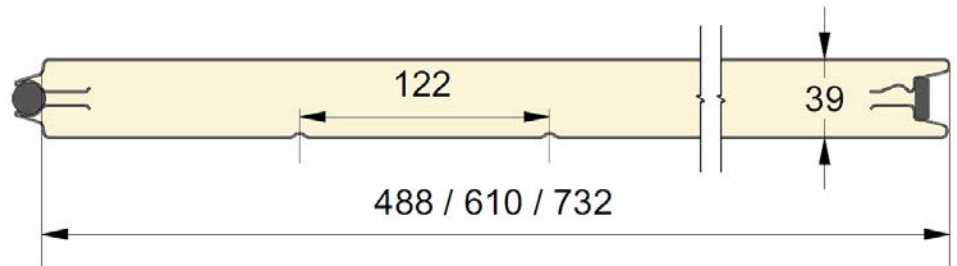

REFERENCE	HEIGHT	EMBOSSING
401	488	Smooth
402	610	Smooth
403	732	Smooth
404	488	Stucco
405	610	Stucco
406	732	Stucco

EMBOSSING



COLORS

	9002	9010	1021	3000	5003 P	5010 P	6009 P	7005	7044	7016 P	8014 P	9006	9007
488	●									○		○	
610	●	●	○	○	○	○	○	○	○	●	○	●	●
732	●									○		○	

● = Standard ○ = Option (min. 100 m²)

EPCO

YOUR NEEDS. OUR PANELS.

Industrial panel with ribbed outer sheet
 Available in heights 488, 610 and 732mm.
 Inner sheet : ribbed, smooth, RAL 9002.

PANEL HL

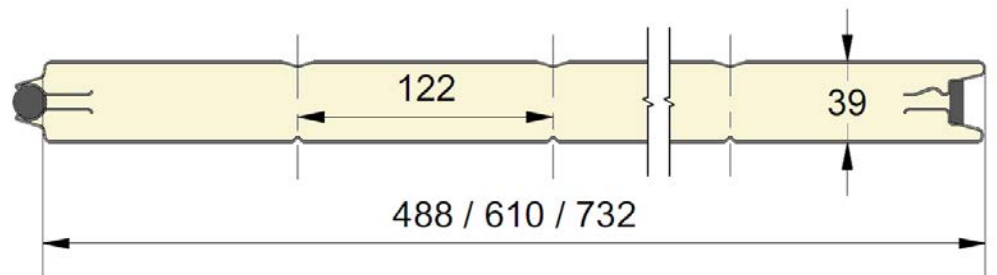

REFERENCE	HEIGHT	EMBOSSING
407	488	Smooth
408	610	Smooth
409	732	Smooth
410	488	Stucco
411	610	Stucco
412	732	Stucco

EMBOSSING



COLORS

	9002	9010	1021	3000	5003 P	5010 P	6009 P	7005	7044	7016 P	8014 P	9006	9007
488	●									○		○	
610	●	●	○	○	○	○	○	○	○	●	○	●	●
732	●									○		○	

● = Standard ○ = Option (min. 100 m²)

EPCO

YOUR NEEDS. OUR PANELS.

Industrial panel with micro ribbed outer sheet
 Available in heights 488, 610 and 732mm.
 Inner sheet : ribbed, smooth, RAL 9002.

PANEL HM8



REFERENCE	HEIGHT	EMBOSSING
413	488	Smooth
414	610	Smooth
415	732	Smooth

EMBOSSING



Smooth

COLORS

	9002	9010	1021	3000	5003 P	5010 P	6009 P	7005	7044	7016 P	8014 P	9006	9007
488	●									○		○	
610	●	●	○	○	○	○	○	○	○	●	○	●	●
732	●									○		○	

● = Standard ○ = Option (min. 100 m²)

EPCO

YOUR NEEDS. OUR PANELS.

Industrial panel with ribbed outer sheet
 Available in heights 500 and 610mm.
 Inner sheet : ribbed, stucco embossed, RAL 9002.

PANEL IF

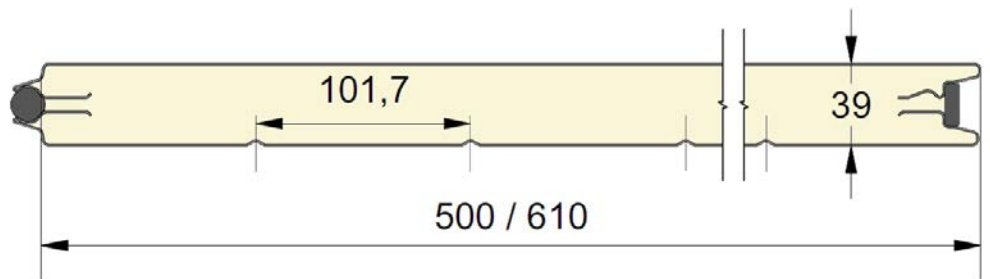

REFERENCE	HEIGHT	EMBOSSING
303	500	Stucco
304	610	Stucco

EMBOSSING



COLORS

	9002	9010	1021	3000	5003 P	5010 P	6009 P	7005	7044	7016 P	8014 P	9006	9007
500	○	●	○	○	○	○	○	○	○	○	○	○	○
610	○	●	○	○	○	○	○	○	○	○	○	○	○

● = Standard ○ = Option (min. 100 m²)

EPCO

YOUR NEEDS. OUR PANELS.

Industrial panel with ribbed outer sheet
 Available in heights 500 and 610mm.
 Inner sheet : ribbed, stucco embossed, RAL 9002.

PANEL **IL**

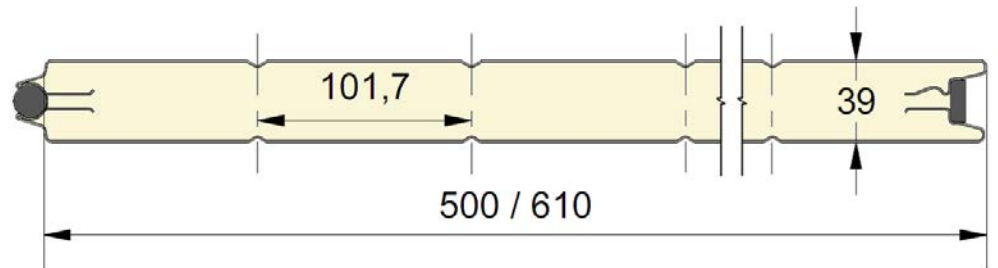

REFERENCE	HEIGHT	EMBOSSING
307	500	Stucco
308	610	Stucco

EMBOSSING



COLORS

	9002	9010	1021	3000	5003 P	5010 P	6009 P	7005	7044	7016 P	8014 P	9006	9007
500	○	●	○	○	○	○	○	○	○	○	○	○	○
610	○	●	○	○	○	○	○	○	○	○	○	○	○

● = Standard ○ = Option (min. 100 m²)

EPCO

YOUR NEEDS. OUR PANELS.

Industrial panel with micro ribbed 8mm outer sheet
 Available in heights 500 and 610mm.
 Inner sheet : ribbed, stucco embossed, RAL 9002.

PANEL IM8

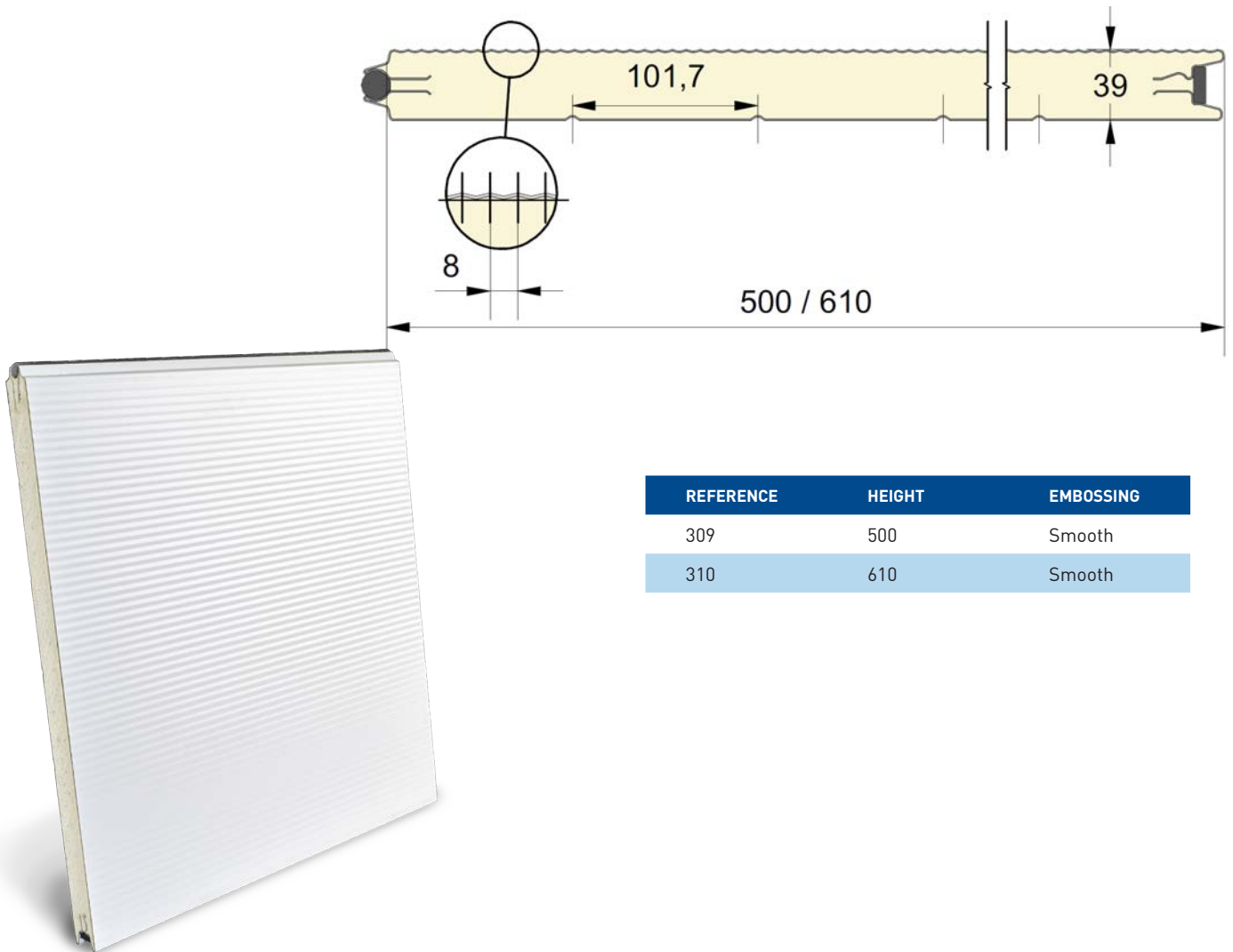

REFERENCE	HEIGHT	EMBOSSING
309	500	Smooth
310	610	Smooth

EMBOSSING



COLORS

	9002	9010	1021	3000	5003 P	5010 P	6009 P	7005	7044	7016 P	8014 P	9006	9007
500	○	●	○	○	○	○	○	○	○	○	○	○	○
610	○	●	○	○	○	○	○	○	○	○	○	○	○

● = Standard ○ = Option (min. 100 m²)

EPCO

YOUR NEEDS. OUR PANELS.

Industrial panel with micro ribbed 16mm outer sheet
 Available in heights 500 and 610mm.
 Inner sheet : ribbed, stucco embossed, RAL 9002.

PANEL IM16

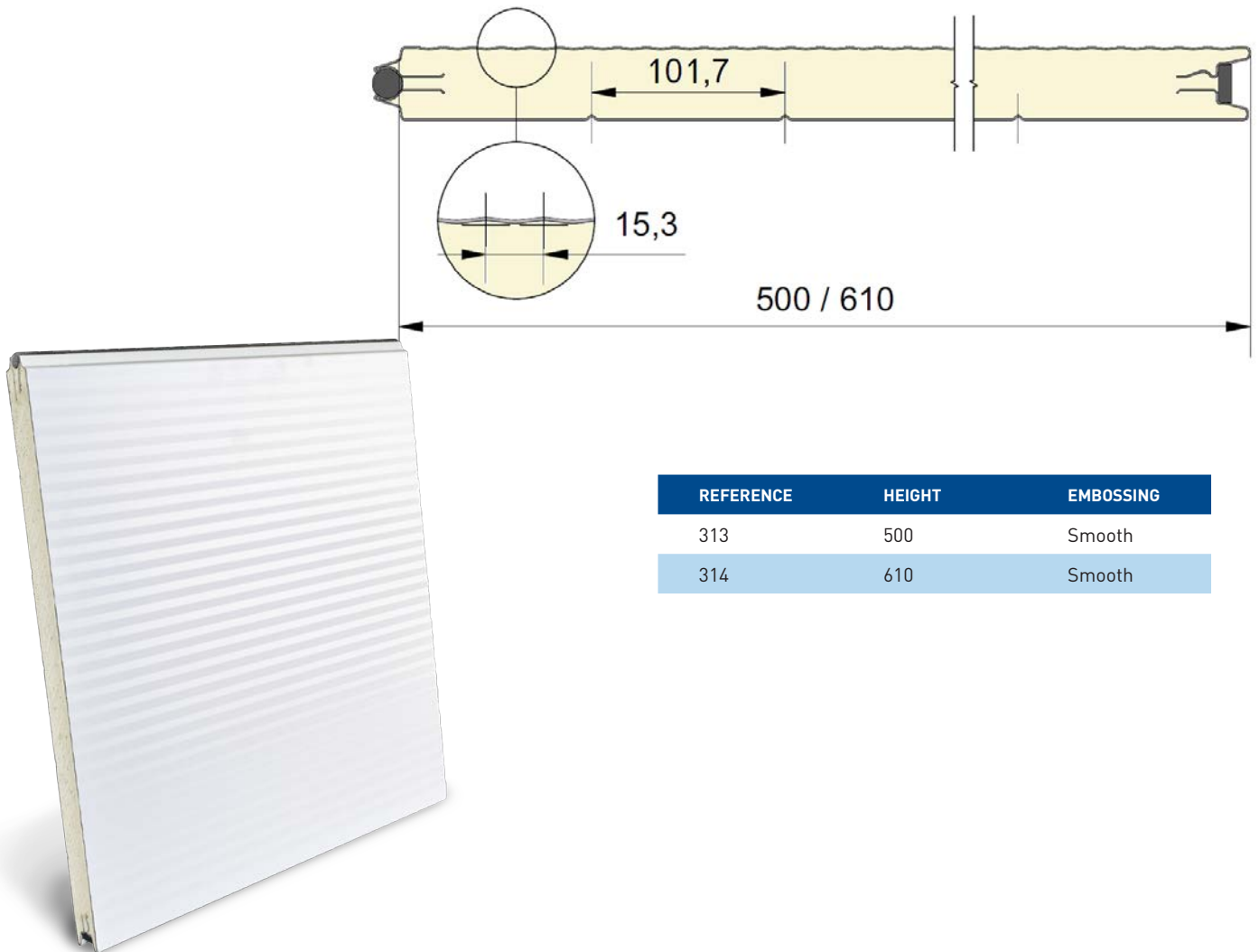

REFERENCE	HEIGHT	EMBOSSING
313	500	Smooth
314	610	Smooth

EMBOSSING



Smooth

COLORS

	9002	9010	1021	3000	5003 P	5010 P	6009 P	7005	7044	7016 P	8014 P	9006	9007
500	○	●	○	○	○	○	○	○	○	○	○	○	○
610	○	●	○	○	○	○	○	○	○	○	○	○	○

● = Standard ○ = Option (min. 100 m²)

EPCO

YOUR NEEDS. OUR PANELS.

60mm industrial panel with ribbed outer face.
 Available in 610mm.
 Inner sheet : ribbed, smooth, RAL 9002.

PANEL XL

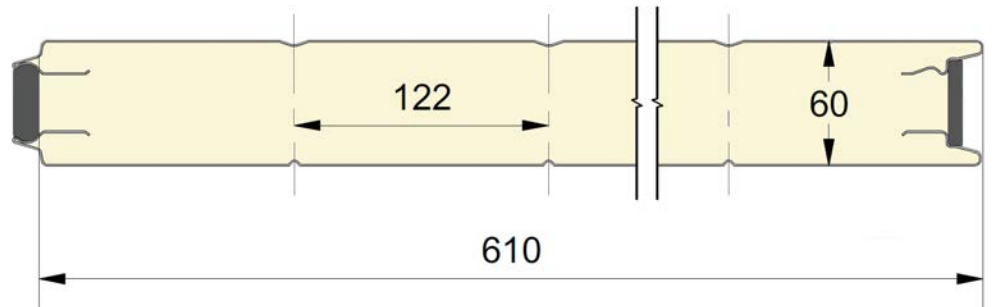

REFERENCE	HEIGHT	EMBOSSING
608	610	Smooth
611	610	Stucco

EMBOSSING



COLORS

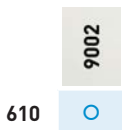

● = Standard ○ = Option (min. 100 m²)

EPCO

YOUR NEEDS. OUR PANELS.

80mm industrial panel with ribbed outer face.
Available in 488 and 610mm.
Both sides ribbed, Stucco embossed, RAL 9002.

PANEL ZL

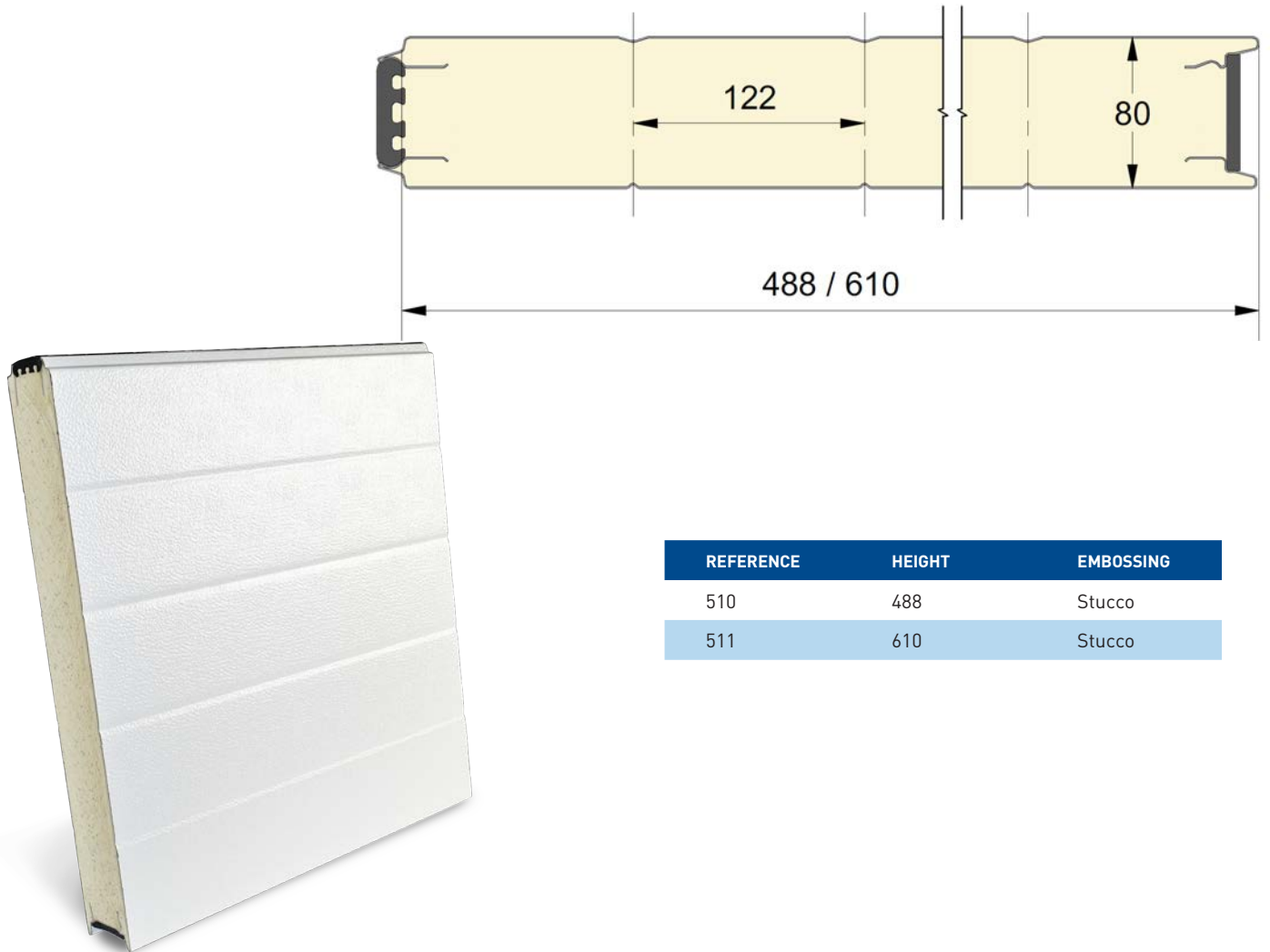

REFERENCE	HEIGHT	EMBOSSING
510	488	Stucco
511	610	Stucco

EMBOSSING



COLORS

	9002	9010	1021	3000	5003 P	5010 P	6009 P	7005	7044	7016 P	8014 P	9006	9007
488	○									○		○	
610	○	○	○	○	○	○	○	○	○	○	○	○	○

● = Standard ○ = Option (min. 100 m²)

EPCO

YOUR NEEDS. OUR PANELS.

Fingersafe panel with flat outer sheet
 Available in heights 500, 555 and 610mm.
 Inner sheet : ribbed, stucco embossed, RAL 9010.

PANEL RF

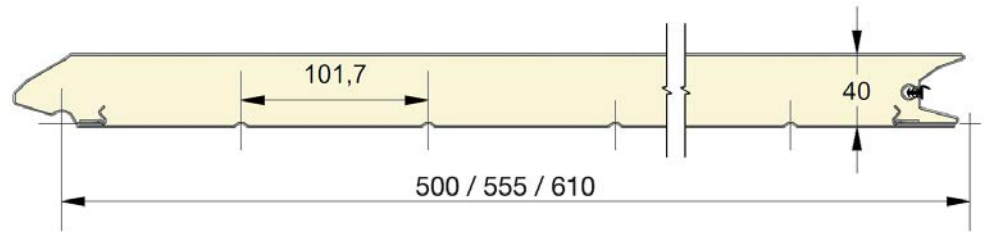

REFERENCE	HEIGHT	EMBOSSING
001	500	Smooth
073	555	Smooth
002	610	Smooth
003	500	Woodgrain
074	555	Woodgrain
004	610	Woodgrain
005	500	Stucco
075	555	Stucco
006	610	Stucco

EMBOSSING



COLORS

	9010	9016 P	1015	6005	6009 P	7016 P	7016 M	7024 M	7035 P	7039 M	8014 P	9006	Golden Oak	Dark Oak	Mahogany	Rustical Oak	White Oak	Grey	PGold	PLight	PDark	PMaha	
500	●+	●*	○	○	○	●	●*	○*	○	●*	○	○+	●	●	○	○	○*	○*	○	○	○	○	○
555	●+	●*				●	○*	○*		○*			●	○					○	○	○	○	○
610	●+	●*	○			●	●*		○		○	○+	●	●	○	○			○	○	○	○	○

● = Standard ○ = Option (min. 100 m²) * = Only in smooth + = Except in smooth

EPCO

YOUR NEEDS. OUR PANELS.

Fingersafe panel with ribbed outer sheet
 Available in heights 500 and 610mm.
 Inner sheet : ribbed, stucco embossed, RAL 9010.

PANEL RL

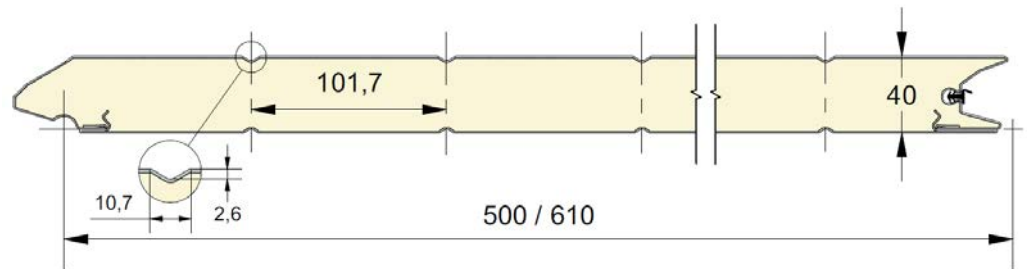

REFERENCE	HEIGHT	EMBOSSING
007	500	Smooth
008	610	Smooth
009	500	Woodgrain
010	610	Woodgrain
011	500	Stucco
012	610	Stucco

EMBOSSING



COLORS

	9010	9016 P	1015	6005	6009 P	7016 P	7016 M	7024 M	7035 P	7039 M	8014 P	9006	Golden Oak	Dark Oak	Mahogany	Rustical Oak	White Oak	Grey	PGold	PLight	PDark	PMaha	
500	●+	●*	○	○	○	●	●*	○*	○*	●*	○	○+	●	●	○	○	○*	○*	○	○	○	○	○
610	●+	●*	○			●	●*		○*		○	○+	●	●	○	○			○	○	○	○	○

● = Standard ○ = Option (min. 100 m²) * = Only in smooth + = Except in smooth

EPCO

YOUR NEEDS. OUR PANELS.

Fingersafe panel with 8mm micro ribbed outer sheet.
Available in heights 500, 555 and 610mm.
Inner sheet: ribbed, stucco embossed, RAL 9010.

PANEL RM8

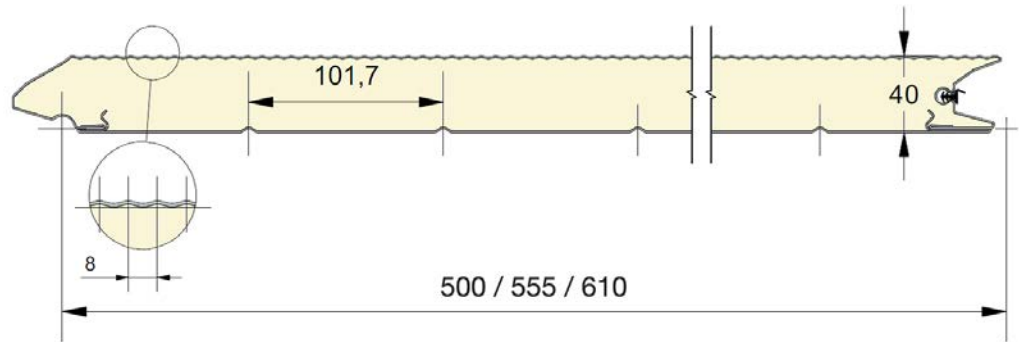

REFERENCE	HEIGHT	EMBOSSING
013	500	Smooth
076	555	Smooth
014	610	Smooth

EMBOSSING



Smooth

COLORS

	9016 P	1015	6005	6009 P	7016 P	7016 M	7024 M	7035 P	7039 M	8014 P	9006	Grey	INOX
500	●	○	○	○	●	●*	○*	○	●*	○	○	○	○
555	●				●	○*	○*		○*				
610	●	○			●	●*		○		○	○		

● = Standard ○ = Option (min. 100 m²) * = Only in smooth

EPCO

YOUR NEEDS. OUR PANELS.

Fingersafe panel with 16mm micro ribbed outer sheet.
 Available in heights 500, 555 and 610mm.
 Inner sheet: ribbed, stucco embossed, RAL 9010.

PANEL RM16

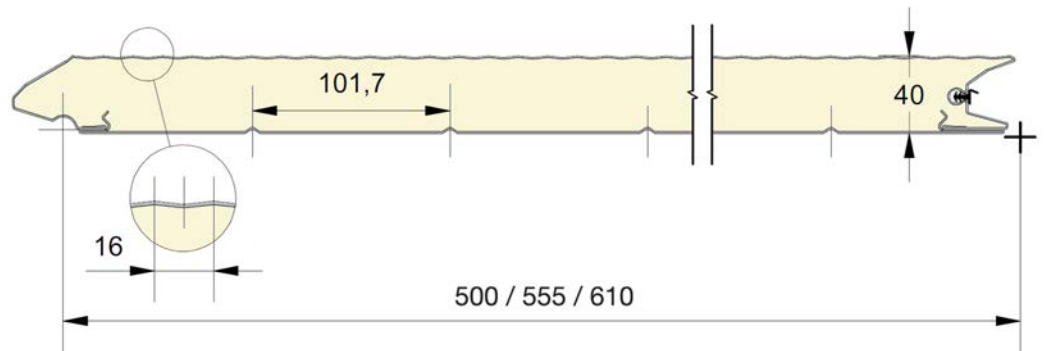

REFERENCE	HEIGHT	EMBOSSING
019	500	Smooth
077	555	Smooth
020	610	Smooth

EMBOSSING



Smooth

COLORS

	9016 P	1015	6005	6009 P	7016 P	7016 M	7024 M	7035 P	7039 M	8014 P	9006	Grey	INOX
500	●	○	○	○	●	●*	○*	○	●*	○	○	○	○
555	●				●	○*	○*		○*				
610	●	○			●	●*		○		○	○		

● = Standard ○ = Option (min. 100 m²) * = Only in smooth

EPCO

YOUR NEEDS. OUR PANELS.

Fingersafe panel with single grooved outer sheet
 Available in heights 500, 555 and 610mm with groove centered, up or down.
 Inner sheet ribbed, stucco embossed, RAL 9010.

PANEL RV

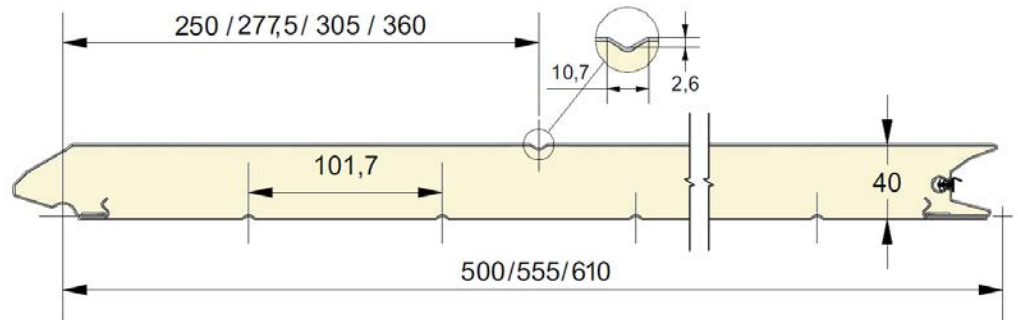

REFERENCE	HEIGHT	EMBOSSING
025	500	Smooth
078	555	Smooth
026	610 CN	Smooth
027	610 UP	Smooth
028	610 DN	Smooth
029	500	Woodgrain
079	555	Woodgrain
030	610 CN	Woodgrain
031	610 UP	Woodgrain
032	610 DN	Woodgrain
033	500	Stucco
080	555	Stucco
034	610 CN	Stucco
035	610 UP	Stucco
036	610 DN	Stucco

EMBOSSING

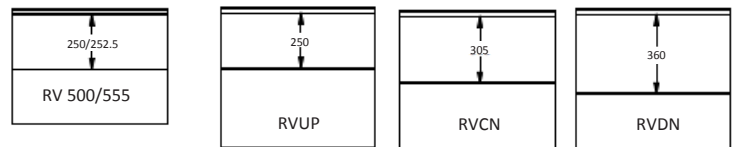

COLORS

	9010	9016 P	1015	6005	6009 P	7016 P	7016 M	7024 M	7035 P	7039 M	8014 P	9006	Golden Oak	Dark Oak	Mahogany	Rustical Oak	White Oak	Grey	PGold	PLight	PDark	PWaha	
500	●+	●*	○	○	○	●	●*	○*	○	●*	○	○+	●	●	○	○	○*	○*	○	○	○	○	○
555	●+	●*				●	○*	○*		○*			●	○					○	○	○	○	○
610	●+	●*	○			●	●*		○		○	○+	●	●	○	○			○	○	○	○	○

● = Standard ○ = Option (min. 100 m²) * = Only in smooth + = Except in smooth

EPCO

YOUR NEEDS. OUR PANELS.

Fingersafe panel with top single grooved outer sheet
 Available in heights 500, 555 and 610mm.
 Inner sheet ribbed, stucco embossed, RAL 9010.

PANEL RT

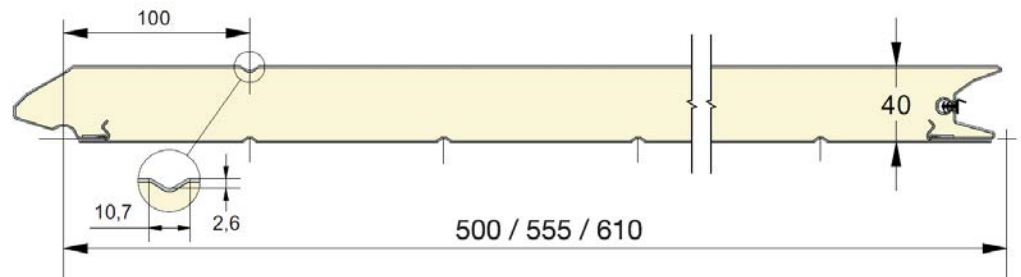

REFERENCE	HEIGHT	EMBOSSING
087	500	Smooth
088	555	Smooth
089	610	Smooth
090	500	Woodgrain
091	555	Woodgrain
092	610	Woodgrain
093	500	Stucco
094	555	Stucco
095	610	Stucco

EMBOSSING



COLORS

	9010	9016 P	1015	6005	6009 P	7016 P	7016 M	7024 M	7035 P	7039 M	8014 P	9006	Golden Oak	Dark Oak	Mahogany	Rustical Oak	White Oak	Grey	PGold	PLight	PDark	PMaha	
500	●+	●*	○	○	○	●	●*	○*	○	●*	○	○+	●	●	○	○	○*	○*	○	○	○	○	○
555	●+	●*				●	○*	○*		○*			●	○					○	○	○	○	○
610	●+	●*	○			●	●*		○		○	○+	●	●	○	○			○	○	○	○	○

● = Standard ○ = Option (min. 100 m²) * = Only in smooth + = Except in smooth

EPCO

YOUR NEEDS. OUR PANELS.

Fingersafe panel with raised cassette in outer sheet
 Available in heights 500, 555 and 610mm with cassette centered, up or down.
 Inner sheet : ribbed, stucco embossed, RAL 9010.

PANEL RC

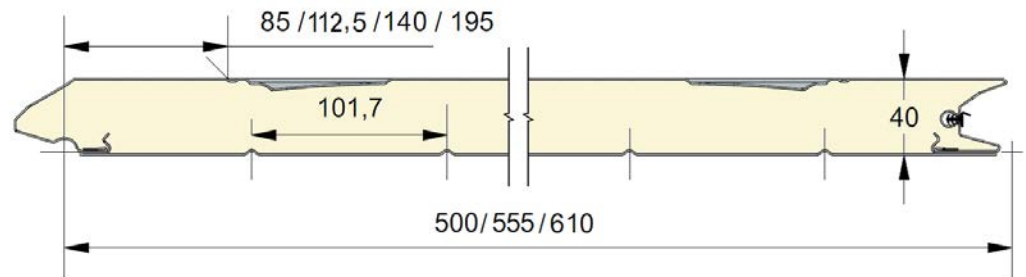

REFERENCE	HEIGHT	EMBOSSING
037	500	Smooth
081	555	Smooth
038	610 CN	Smooth
039	610 UP	Smooth
040	610 DN	Smooth
041	500	Woodgrain
082	555	Woodgrain
042	610 CN	Woodgrain
043	610 UP	Woodgrain
044	610 DN	Woodgrain

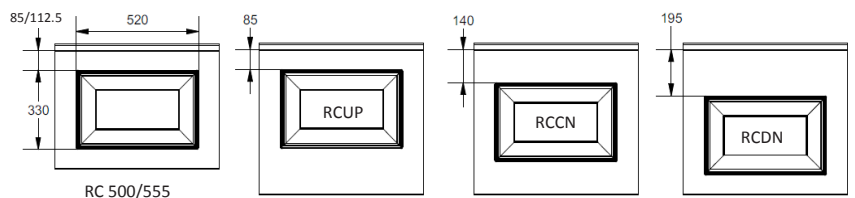

COLORS

	9010	9016 P	8014 P	Golden Oak	Dark Oak	Mahogany	Rustical Oak	White Oak	PGold	PLight	PDark	PMaha
500 WOODGRAIN	●		○	○	○	○	○		○	○	○	○
555 WOODGRAIN	●			○	○				○	○	○	○
610 WOODGRAIN	●		○	○	○	○	○		○	○	○	○
500 SMOOTH		●		●	●	○	○	○	○	○	○	○
555 SMOOTH		●		●	○				○	○	○	○
610 SMOOTH		●		●	●	○	○		○	○	○	○

● = Standard ○ = Option (min. 100 m²)

EMBOSSING



EPCO

YOUR NEEDS. OUR PANELS.

Fingersafe panel with raised big cassette in outer sheet
 Available in heights 500 and 610mm with cassette centered, up or down.
 Inner sheet : ribbed, stucco embossed, RAL 9010.

PANEL RBC

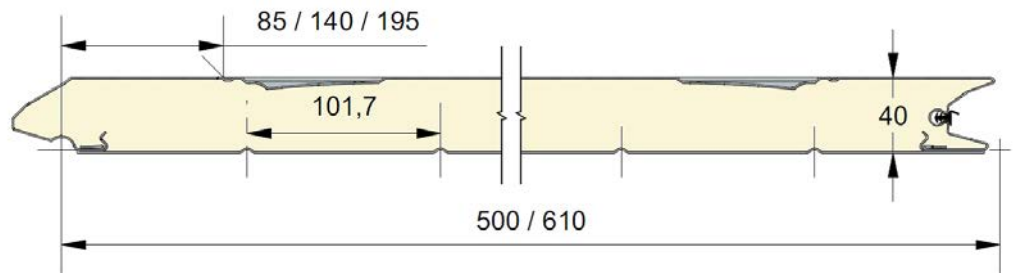

REFERENCE	HEIGHT	EMBOSSING
049	500	Smooth
050	610 CN	Smooth
051	610 UP	Smooth
052	610 DN	Smooth
053	500	Woodgrain
054	610 CN	Woodgrain
055	610 UP	Woodgrain
056	610 DN	Woodgrain

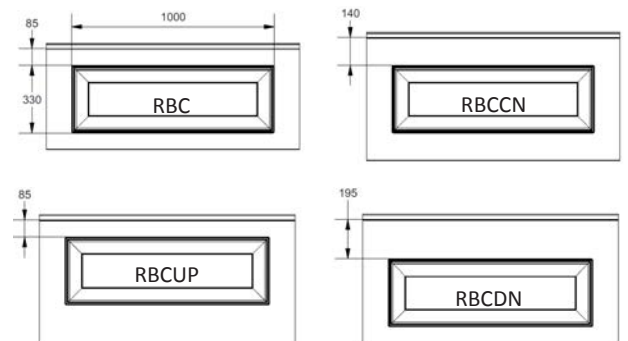

COLORS

	9010	9016 P	8014 P	Golden Oak	Dark Oak	Manogany	Rustical Oak
500 WOODGRAIN	●		○	○	○	○	○
610 WOODGRAIN	●		○	○	○	○	○
500 SMOOTH		●		●	●	○	○
610 SMOOTH		●		●	●	○	○

● = Standard ○ = Option (min. 100 m²)

EMBOSSING



EPCO

YOUR NEEDS. OUR PANELS.

Fingersafe panel with vertical V grooves
 Available in heights 500 and 610mm
 Inner sheet : ribbed, stucco embossed, RAL 9010.

PANEL RVV

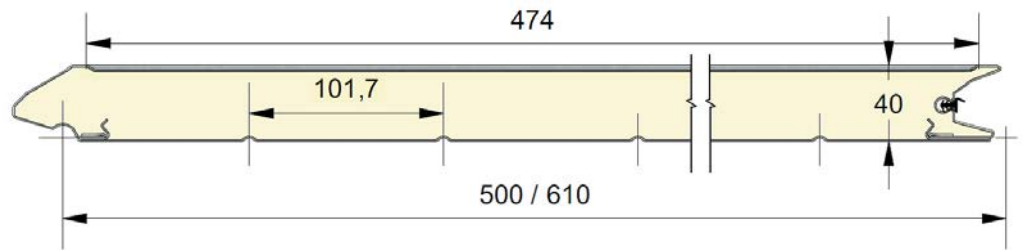

REFERENCE	HEIGHT	EMBOSSING
067	500	Smooth
068	610	Smooth

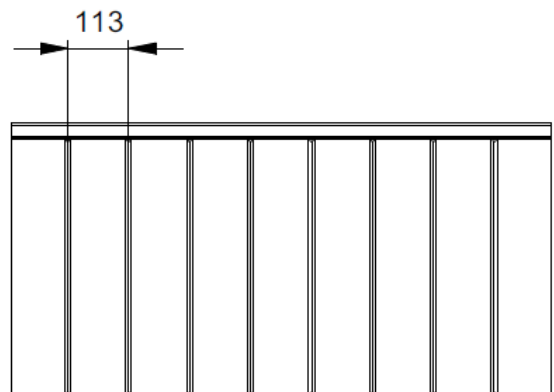

COLORS

	9016 P
500	●
610	●

● = Standard ○ = Option (min. 100 m²)

EMBOSSING



EPCO

YOUR NEEDS. OUR PANELS.

Fingersafe panel with flat outer sheet
 Available in heights 500, 555 and 610mm.
 Inner sheet : ribbed, stucco embossed, RAL 9010.

PANEL UF

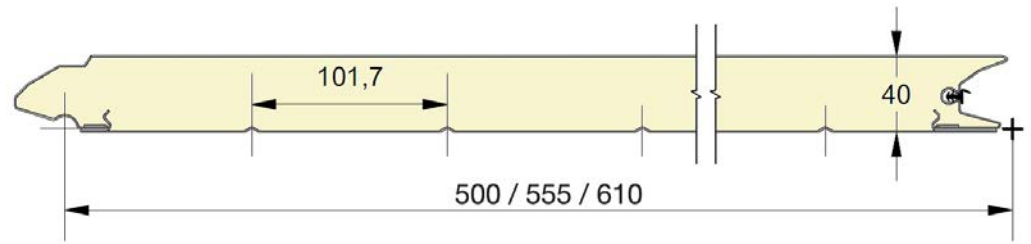

REFERENCE	HEIGHT	EMBOSSING
701	500	Smooth
758	555	Smooth
702	610	Smooth
703	500	Woodgrain
759	555	Woodgrain
704	610	Woodgrain
705	500	Stucco
760	555	Stucco
706	610	Stucco

EMBOSSING



COLORS

	9010	9016 P	1015	6005	6009 P	7016 P	7016 M	7024 M	7035 P	7039 M	8014 P	9006	Golden Oak	Dark Oak	Mahogany	Rustical Oak	White Oak	Grey	PGold	PLight	PDark	PMaha	
500	●+	●*	○	○	○	●	●*	○*	○	●*	○	○+	●	●	○	○	○*	○*	○	○	○	○	○
555	●+	●*				●	○*	○*		○*			●	○					○	○	○	○	○
610	●+	●*	○			●	●*		○		○	○+	●	●	○	○			○	○	○	○	○

● = Standard ○ = Option (min. 100 m²) * = Only in smooth + = Except in smooth

EPCO

YOUR NEEDS. OUR PANELS.

Fingersafe panel with single grooved outer sheet
 Available in heights 500, 555 and 610mm with groove centered, up or down.
 Inner sheet ribbed, stucco embossed, RAL 9010.

PANEL UU

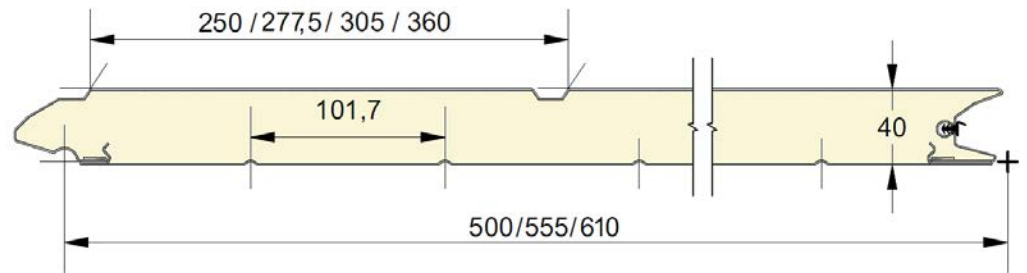

REFERENCE	HEIGHT	EMBOSSING
707	500	Smooth
761	555	Smooth
708	610 CN	Smooth
709	610 UP	Smooth
710	610 DN	Smooth
711	500	Woodgrain
762	555	Woodgrain
712	610 CN	Woodgrain
713	610 UP	Woodgrain
714	610 DN	Woodgrain
715	500	Stucco
763	555	Stucco
716	610 CN	Stucco
717	610 UP	Stucco
718	610 DN	Stucco

EMBOSSING



COLORS

	9010	9016 P	1015	6005	6009 P	7016 P	7016 M	7024 M	7035 P	7039 M	8014 P	9006	Golden Oak	Dark Oak	Mahogany	Rustical Oak	White Oak	Grey	PGold	PLight	PDark	PMaha	
500	●+	●*	○	○	○	●	●*	○*	○	●*	○	○+	●	●	○	○	○*	○*	○	○	○	○	○
555	●+	●*				●	○*	○*		○*			●	○					○	○	○	○	○
610	●+	●*	○			●	●*		○		○	○+	●	●	○	○			○	○	○	○	○

● = Standard ○ = Option (min. 100 m²) * = Only in smooth + = Except in smooth

EPCO

YOUR NEEDS. OUR PANELS.

Fingersafe panel with 8mm micro ribbed outer sheet.
 Available in heights 500, 555 and 610mm.
 Inner sheet: ribbed, stucco embossed, RAL 9010.

PANEL UM8

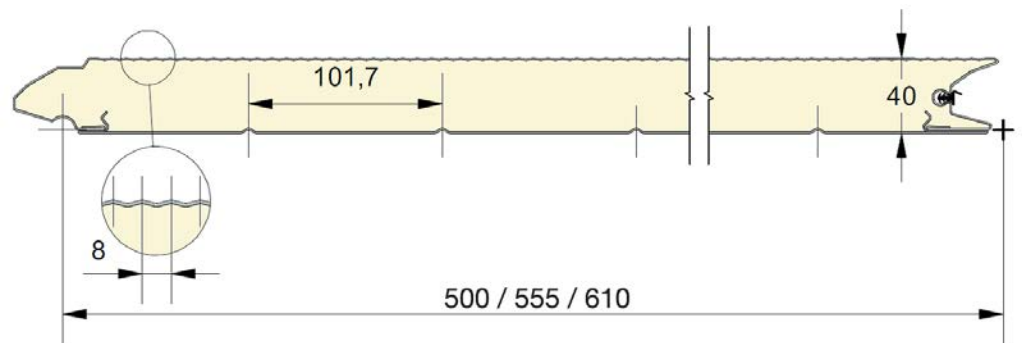

REFERENCE	HEIGHT	EMBOSSING
719	500	Smooth
764	555	Smooth
720	610	Smooth

EMBOSSING



Smooth

COLORS

	9016 P	1015	6005	6009 P	7016 P	7016 M	7024 M	7035 P	7039 M	8014 P	9006	Grey	INOX
500	●	○	○	○	●	●*	○*	○	●*	○	○	○	○
555	●				●	○*	○*		○*				
610	●	○			●	●*		○		○	○		

● = Standard ○ = Option (min. 100 m²) * = Only in smooth

EPCO

YOUR NEEDS. OUR PANELS.

Fingersafe panel with 16mm micro ribbed outer sheet.
 Available in heights 500, 555 and 610mm.
 Inner sheet: ribbed, stucco embossed, RAL 9010.

PANEL UM16

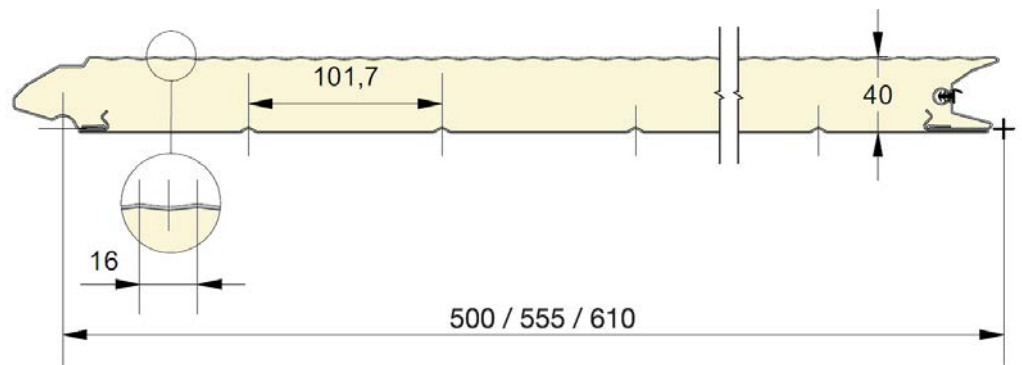

REFERENCE	HEIGHT	EMBOSSING
749	500	Smooth
765	555	Smooth
750	610	Smooth

EMBOSSING



Smooth

COLORS

	9016 P	1015	6005	6009 P	7016 P	7016 M	7024 M	7035 P	7039 M	8014 P	9006	Grey	INOX
500	●	○	○	○	●	●*	○*	○	●*	○	○	○	○
555	●				●	○*	○*		○*				
610	●	○			●	●*		○		○	○		

● = Standard ○ = Option (min. 100 m²) * = Only in smooth

EPCO

YOUR NEEDS. OUR PANELS.

Fingersafe panel with single grooved and 8mm micro ribbed outer sheet.
Available in heights 500 and 610mm.
Inner sheet: ribbed, stucco embossed, RAL 9010.

PANEL UUM8

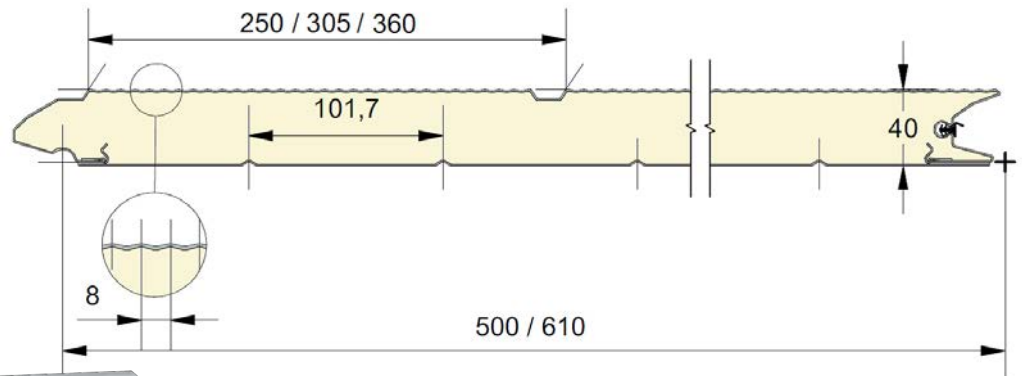

REFERENCE	HEIGHT	EMBOSSING
721	500	Smooth
722	610 CN	Smooth
723	610 UP	Smooth
724	610 DN	Smooth

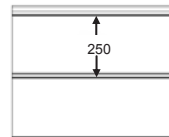

UUM8

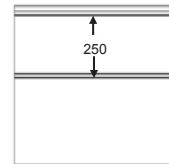

UUM8UP

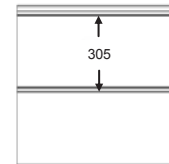

UUM8CN

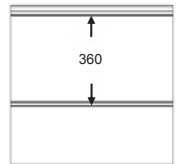

UUM8DN

EMBOSSING



Smooth

COLORS

	9016 P	1015	6005	6009 P	7016 P	7016 M	7024 M	7035 P	7039 M	8014 P	9006	Grey	INOX
500	●	○	○	○	●	●*	○*	○	●*	○	○	○	○
610	●	○			●	●*		○		○	○		

● = Standard ○ = Option (min. 100 m²) * = Only in smooth

EPCO

YOUR NEEDS. OUR PANELS.

Fingersafe panel with single grooved and 16mm micro ribbed outer sheet.
Available in heights 500 and 610mm.
Inner sheet: ribbed, stucco embossed, RAL 9010.

PANEL UUM16

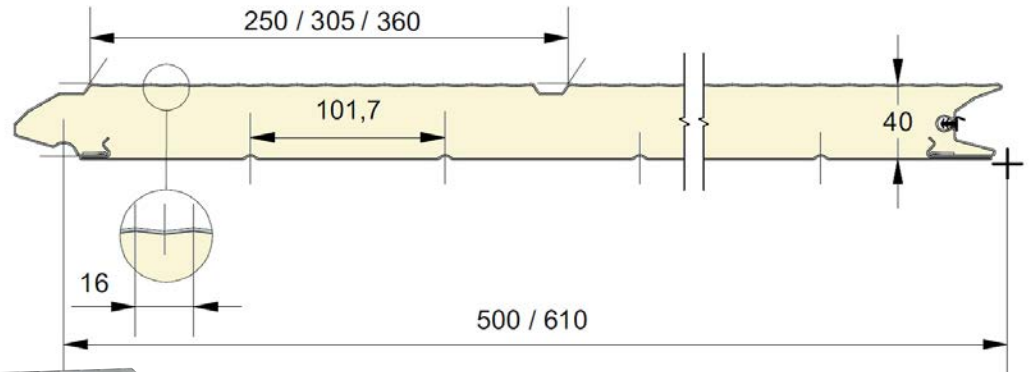

REFERENCE	HEIGHT	EMBOSSING
751	500	Smooth
752	610 CN	Smooth
753	610 UP	Smooth
754	610 DN	Smooth



UUM16

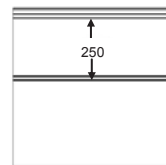

UUM16UP

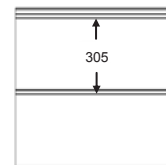

UUM16CN

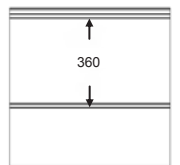

UUM16DN

EMBOSSING



Smooth

COLORS

	9016 P	1015	6005	6009 P	7016 P	7016 M	7024 M	7035 P	7039 M	8014 P	9006	Grey	INOX
500	●	○	○	○	●	●*	○*	○	●*	○	○	○	○
610	●	○			●	●*		○		○	○		

● = Standard ○ = Option (min. 100 m²) * = Only in smooth

EPCO

YOUR NEEDS. OUR PANELS.

Fingersafe panel with upper grooved outer sheet.
Available in heights 500, 555 and 610mm.
Inner sheet: ribbed, stucco embossed, RAL 9010.

PANEL UT

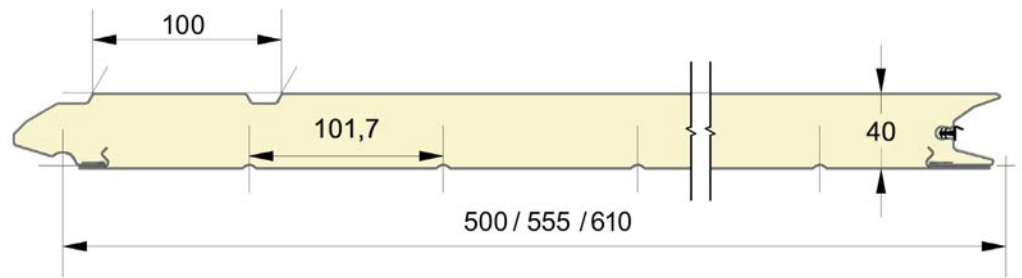

REFERENCE	HEIGHT	EMBOSSING
781	500	Smooth
782	555	Smooth
783	610	Smooth
784	500	Woodgrain
785	555	Woodgrain
786	610	Woodgrain
787	500	Stucco
788	555	Stucco
789	610	Stucco

EMBOSSING



COLORS

	9010	9016 P	1015	6005	6009 P	7016 P	7016 M	7024 M	7035 P	7039 M	8014 P	9006	Golden Oak	Dark Oak	Mahogany	Rustical Oak	White Oak	Grey	PGold	PLight	PDark	PMaha	
500	●+	●*	○	○	○	○	○*	○*	○	○*	○	○+	○	○	○	○	○*	○*	○	○	○	○	○
555	●+	●*					○*	○*		○*				○					○	○	○	○	○
610	●+	●*	○			○	○*		○		○	○+	○	○	○	○			○	○	○	○	○

● = Standard ○ = Option (min. 100 m²) * = Only in smooth + = Except in smooth

EPCO

YOUR NEEDS. OUR PANELS.

Fingersafe panel with multiple grooves on the outer sheet.
 Available in heights 500 and 625mm.
 Inner sheet: ribbed, stucco embossed, RAL 9010.

PANEL UW

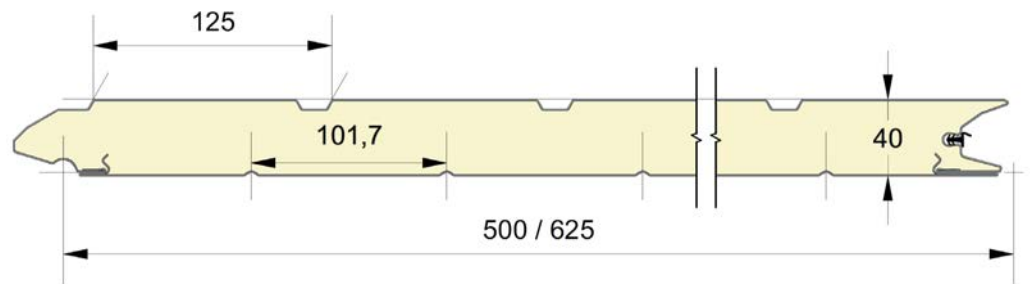

REFERENCE	HEIGHT	EMBOSSING
756	500	Woodgrain
757	500	Stucco
776	625	Woodgrain
777	625	Stucco

COLORS

	9010
500	○
625	○
	● = Standard ○ = Option (min. 100 m ²)

EMBOSSING



EPCO

YOUR NEEDS. OUR PANELS.

Fingersafe panel with flat outer sheet
 Available in heights 500 and 610mm.
 Inner sheet : ribbed, stucco embossed, RAL 9010.

PANEL FF

Reco
 SERIES

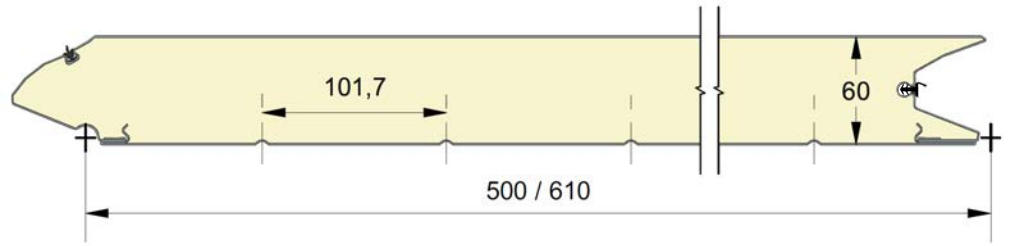

REFERENCE	HEIGHT	EMBOSSING
801	500	Smooth
802	610	Smooth
803	500	Woodgrain
804	610	Woodgrain
805	500	Stucco
806	610	Stucco

COLORS

	9010	9016 P	Golden Oak	7016 P
500	○+	●*	○	○
610	○+	●*		

EMBOSSING



● = Standard ○ = Option (min. 100 m²) * = Only in smooth + = Except in smooth

EPCO

YOUR NEEDS. OUR PANELS.

Fingersafe panel with ribbed outer sheet
 Available in heights 500 and 610mm.
 Inner sheet : ribbed, stucco embossed, RAL 9010.

PANEL FL

Reco
 SERIES

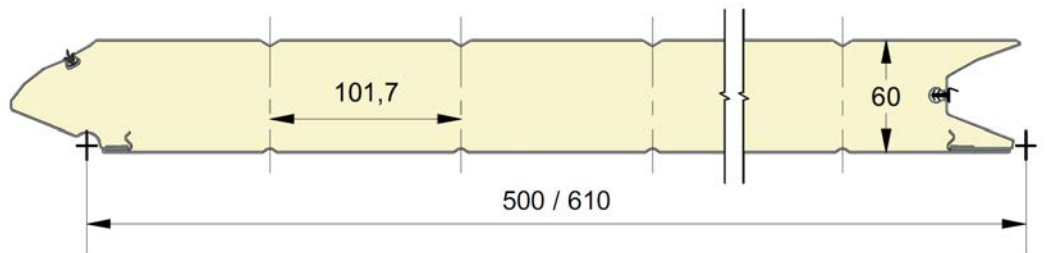

REFERENCE	HEIGHT	EMBOSSING
807	500	Smooth
808	610	Smooth
809	500	Woodgrain
810	610	Woodgrain
811	500	Stucco
812	610	Stucco

COLORS

	9010	9016 P	Golden Oak	7016 P
500	○+	●*	○	○
610	○+	●*		

● = Standard ○ = Option (min. 100 m²) * = Only in smooth + = Except in smooth

EMBOSSING



EPCO

YOUR NEEDS. OUR PANELS.

Fingersafe panel with 8mm micro ribbed outer sheet.
 Available in heights 500 and 610mm.
 Inner sheet: ribbed, stucco embossed, RAL 9010.

PANEL FM8

Reco
 SERIES

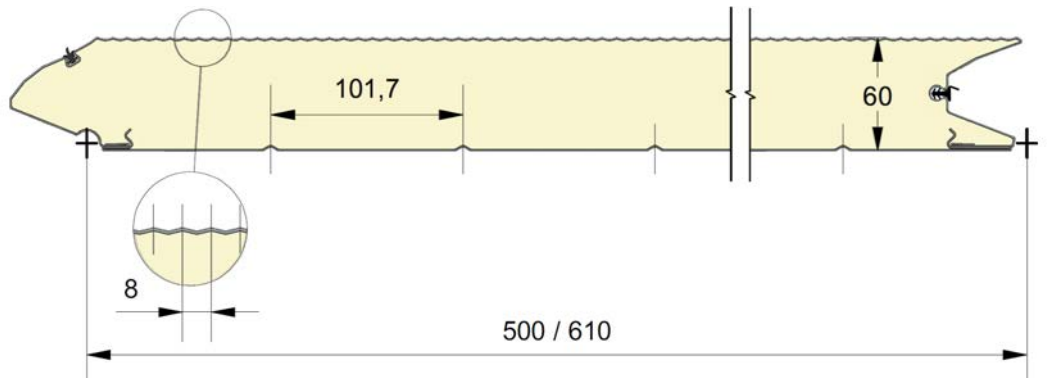

REFERENCE	HEIGHT	EMBOSSING
813	500	Smooth
814	610	Smooth

COLORS

	9016 P	7016 P
500	●	○
610	●	

● = Standard ○ = Option (min. 100 m²)

EMBOSSING



EPCO

YOUR NEEDS. OUR PANELS.

Fingersafe panel with 16mm micro ribbed outer sheet.
 Available in heights 500 and 610mm.
 Inner sheet: ribbed, stucco embossed, RAL 9010.

PANEL FM16

Reco
 SERIES

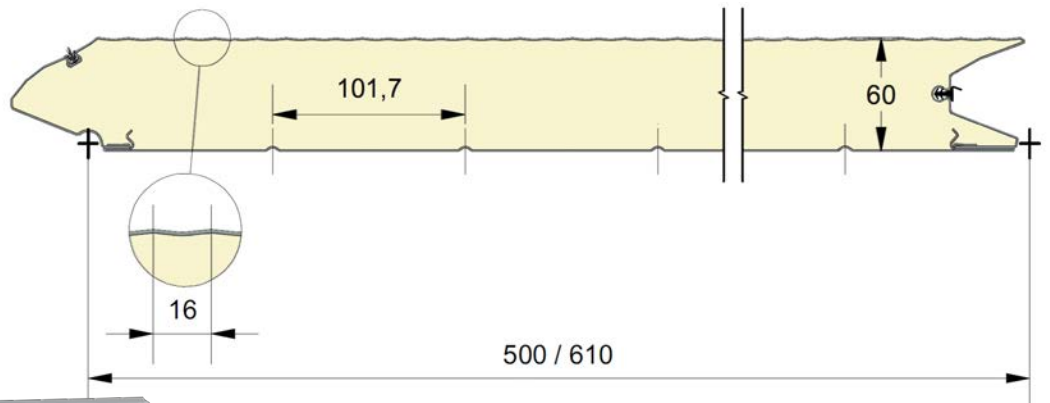

REFERENCE	HEIGHT	EMBOSSING
819	500	Smooth
820	610	Smooth

COLORS

	9016 P	7016 P
500	●	○
610	●	

● = Standard ○ = Option (min. 100 m²)

EMBOSSING



EPCO

YOUR NEEDS. OUR PANELS.

Fingersafe panel with single grooved outer sheet.
 Available in heights 500 and 610mm with groove centered, up or down.
 Inner sheet: ribbed, stucco embossed, RAL 9010.

PANEL FV

Reco
SERIES

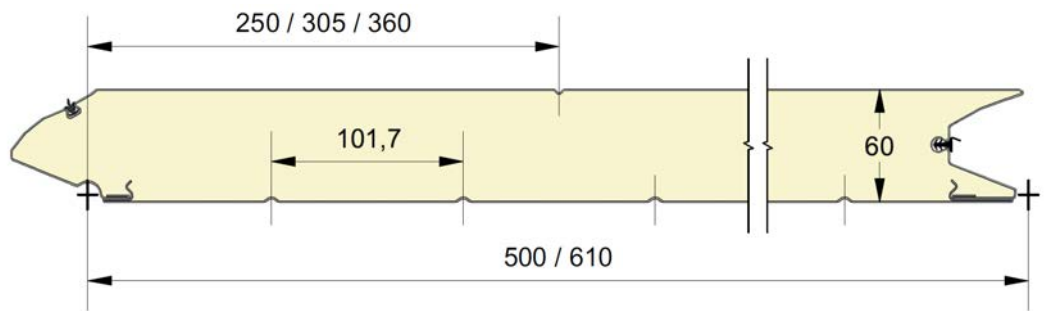

REFERENCE	HEIGHT	EMBOSSING
825	500	Smooth
826	610 CN	Smooth
827	610 UP	Smooth
828	610 DN	Smooth
829	500	Woodgrain
830	610 CN	Woodgrain
831	610 UP	Woodgrain
832	610 DN	Woodgrain
833	500	Stucco
834	610 CN	Stucco
835	610 UP	Stucco
836	610 DN	Stucco



COLORS

	9010	9016 P	Golden Oak	7016 P
500	○+	●*	○	○
610	○+	●*		

EMBOSSING



● = Standard ○ = Option (min. 100 m²) * = Only in smooth + = Except in smooth

EPCO

YOUR NEEDS. OUR PANELS.

Fingersafe panel with raised cassette in outer sheet.
 Available in heights 500 and 610mm with cassette centered, up or down.
 Inner sheet: ribbed, stucco embossed, RAL 9010.

PANEL FC

Eco
SERIES

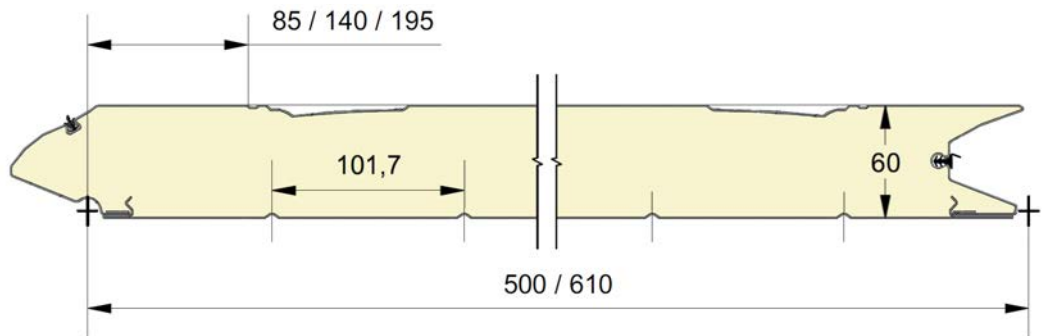

REFERENCE	HEIGHT	EMBOSSING
837	500	Smooth
838	610 CN	Smooth
839	610 UP	Smooth
840	610 DN	Smooth
841	500	Woodgrain
842	610 CN	Woodgrain
843	610 UP	Woodgrain
844	610 DN	Woodgrain
845	500	Stucco
846	610 CN	Stucco
847	610 UP	Stucco
848	610 DN	Stucco

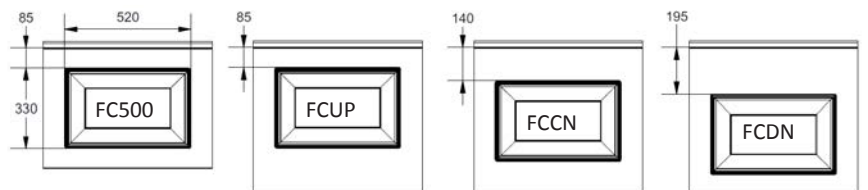

COLORS

	9010	9016 P	Golden Oak
500	○+	●*	○
610	○+	●*	

EMBOSSING



● = Standard ○ = Option (min. 100 m²) * = Only in smooth + = Except in smooth

EPCO

YOUR NEEDS. OUR PANELS.

Fingersafe panel with flat outer sheet
 Available in heights 500 and 610mm.
 Inner sheet : ribbed, stucco embossed, RAL 9010.

PANEL GF

Reco
 SERIES

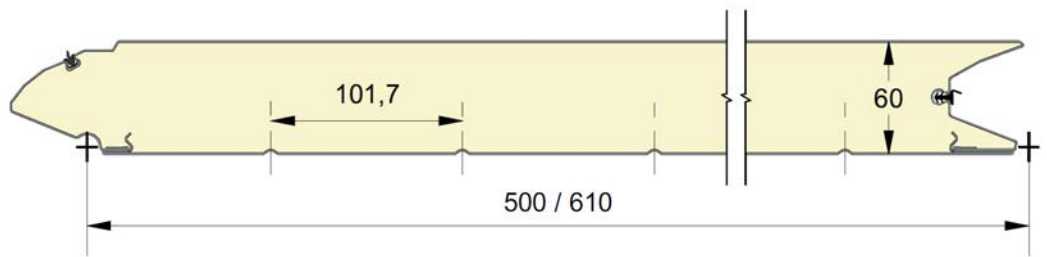

REFERENCE	HEIGHT	EMBOSSING
901	500	Smooth
902	610	Smooth
903	500	Woodgrain
904	610	Woodgrain
905	500	Stucco
906	610	Stucco

COLORS

	9010	9016 P	Golden Oak	7016 P
500	○+	●*	○	○
610	○+	●*		

● = Standard ○ = Option (min. 100 m²) * = Only in smooth + = Except in smooth

EMBOSSING



EPCO

YOUR NEEDS. OUR PANELS.

Fingersafe panel with single grooved outer sheet.
 Available in heights 500 and 610mm with groove centered, up or down.
 Inner sheet: ribbed, stucco embossed, RAL 9010.

PANEL **GU**

Reco
SERIES

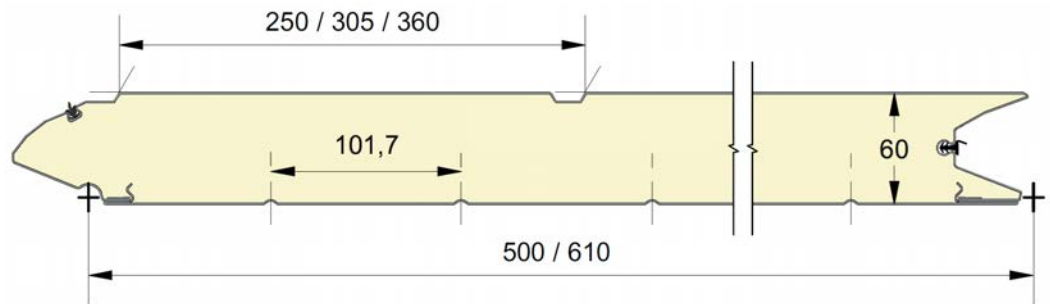

REFERENCE	HEIGHT	EMBOSSING
907	500	Smooth
908	610 CN	Smooth
909	610 UP	Smooth
910	610 DN	Smooth
911	500	Woodgrain
912	610 CN	Woodgrain
913	610 UP	Woodgrain
914	610 DN	Woodgrain
915	500	Stucco
916	610 CN	Stucco
917	610 UP	Stucco
918	610 DN	Stucco

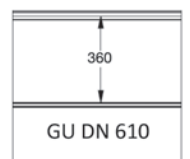
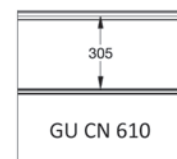
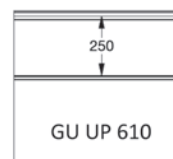
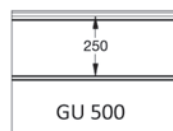

COLORS

	9010	9016 P	Golden Oak	7016 P
500	○+	●*	○	○
610	○+	●*		

EMBOSSING



● = Standard ○ = Option (min. 100 m²) * = Only in smooth + = Except in smooth

EPCO

YOUR NEEDS. OUR PANELS.

Fingersafe panel with upper grooved outer sheet.
 Available in heights 500 and 610mm.
 Inner sheet: ribbed, stucco embossed, RAL 9010.

PANEL GT

Reco
 SERIES

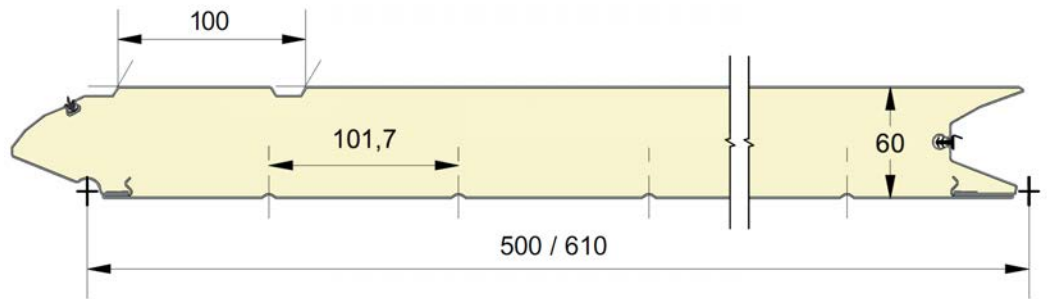

REFERENCE	HEIGHT	EMBOSSING
955	500	Smooth
956	610	Smooth
957	500	Woodgrain
958	610	Woodgrain
959	500	Stucco
960	610	Stucco

COLORS

	9010	9016 P	Golden Oak	7016 P
500	○+	●*	○	○
610	○+	●*		

EMBOSSING



● = Standard ○ = Option (min. 100 m²) * = Only in smooth + = Except in smooth

EPCO

YOUR NEEDS. OUR PANELS.

Fingersafe panel with 16mm micro ribbed outer sheet.
 Available in heights 500 and 610mm.
 Inner sheet: ribbed, stucco embossed, RAL 9010.

PANEL GM8

Reco
SERIES

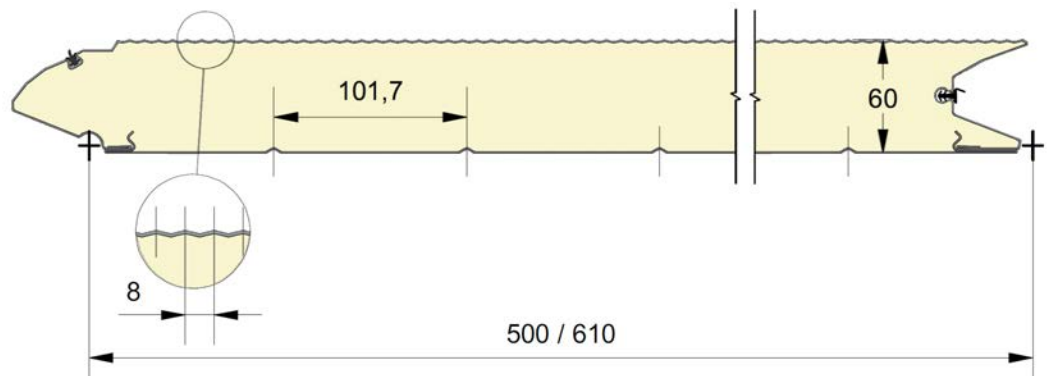

REFERENCE	HEIGHT	EMBOSSING
919	500	Smooth
920	610	Smooth

COLORS

	9016 P	7016 P
500	●	○
610	●	

● = Standard ○ = Option (min. 100 m²)

EMBOSSING



EPCO

YOUR NEEDS. OUR PANELS.

Fingersafe panel with 16mm micro ribbed outer sheet.
 Available in heights 500 and 610mm.
 Inner sheet: ribbed, stucco embossed, RAL 9010.

PANEL GM16

Reco
 SERIES

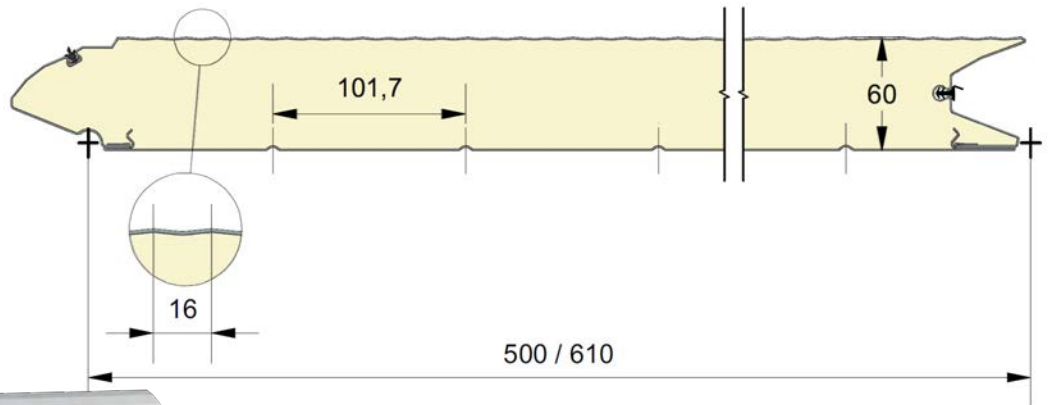

REFERENCE	HEIGHT	EMBOSSING
949	500	Smooth
950	610	Smooth

COLORS

	9016 P	7016 P
500	●	○
610	●	

● = Standard ○ = Option (min. 100 m²)

EMBOSSING



EPCO

YOUR NEEDS. OUR PANELS.

Fingersafe panel with single grooved and 8mm micro ribbed outer sheet.

Available in heights 500 and 610mm.

Inner sheet: ribbed, stucco embossed, RAL 9010.

PANEL GUM8

Reco
SERIES

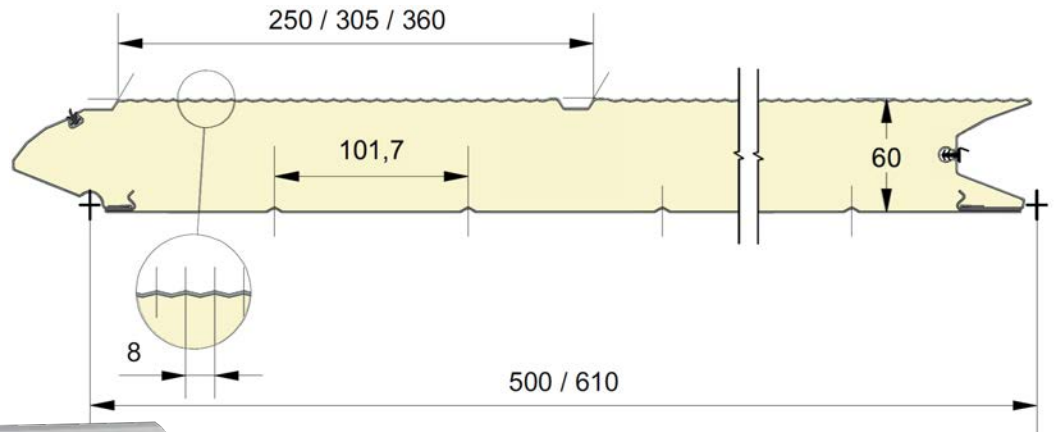

REFERENCE	HEIGHT	EMBOSSING
921	500	Smooth
922	610 CN	Smooth
923	610 UP	Smooth
924	610 DN	Smooth

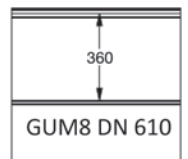
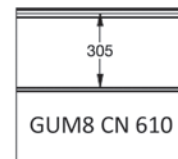
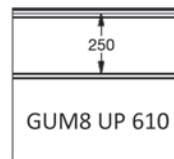
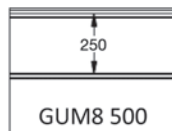

COLORS

	9016 P	7016 P
500	●	○
610	●	

● = Standard ○ = Option (min. 100 m²)

EMBOSSING



EPCO

YOUR NEEDS. OUR PANELS.

Fingersafe panel with single grooved and 16mm micro ribbed outer sheet.

Available in heights 500 and 610mm.

Inner sheet: ribbed, stucco embossed, RAL 9010.

PANEL GUM16

Reco
SERIES

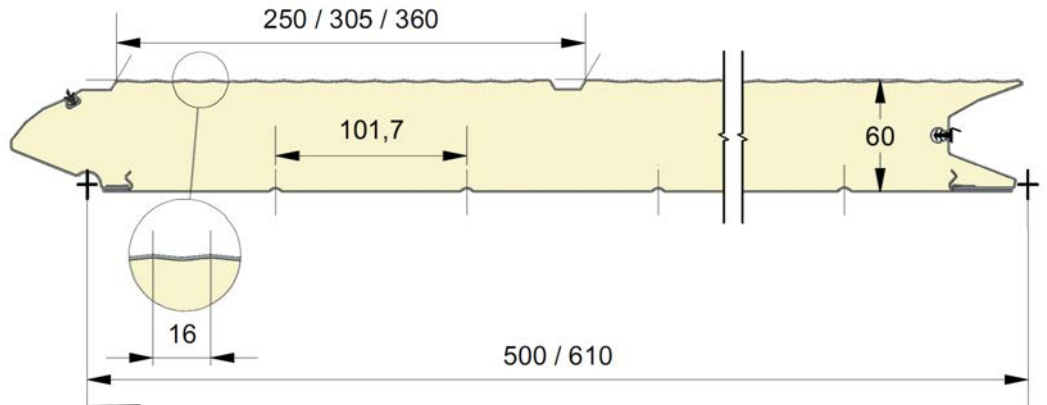

REFERENCE	HEIGHT	EMBOSSING
951	500	Smooth
952	610 CN	Smooth
953	610 UP	Smooth
954	610 DN	Smooth

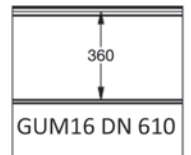
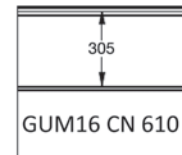
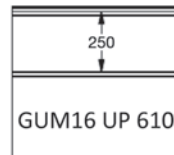
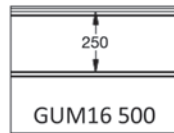

COLORS

	9016 P	7016 P
500	●	○
610	●	

● = Standard ○ = Option (min. 100 m²)

EMBOSSING



EPCO

YOUR NEEDS. OUR PANELS.

Fingersafe panel with flat outer sheet
available in heights 366, 500, 553 and 610mm.
Inner sheet : ribbed, stucco embossed, RAL 9010.

PANEL SF

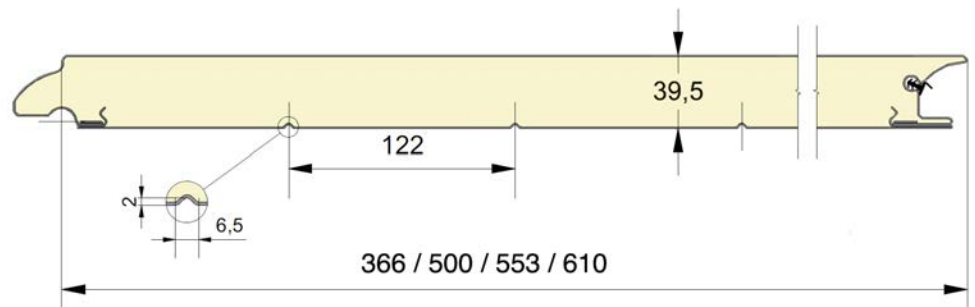

REFERENCE	HAUTEUR	EMBOSSAGE
1201	500	Smooth
1281	553	Smooth
1202	610	Smooth
1203	500	Woodgrain
1282	553	Woodgrain
1204	610	Woodgrain
1270	366	Stucco
1205	500	Stucco
1283	553	Stucco
1206	610	Stucco

EMBOSSING



COLORS

	9002	9010	9016 P	1015	6005	6009 P	7016 P	7016 M	7024 M	7035 P	7039 M	8014 P	9006	PGold	PLight	PDark	PMaha
366	○																
500	●+	○+	●*	○	○	○	○	○*	○*	○*	○*	○	○+	○	○	○	○
553		○+	●*				○	○*	○*		○*			○	○	○	○
610	●+	○+	●*	○			○	○*		○*		○	○+	○	○	○	○

● = Standard ○ = Option (min. 100 m²) * = Only in smooth + = Except in smooth

EPCO

YOUR NEEDS. OUR PANELS.

Fingersafe panel with ribbed outer sheet
 Available in heights 500 and 610mm.
 Inner sheet : ribbed, stucco embossed, RAL 9010.

PANEL **SL**

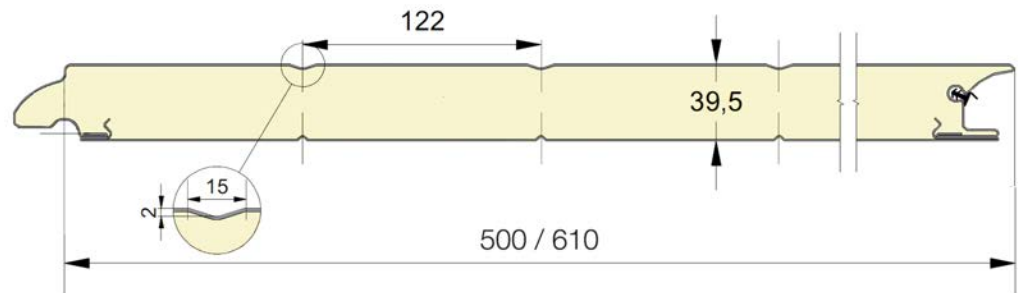

REFERENCE	HEIGHT	EMBOSSING
1207	500	Smooth
1208	610	Smooth
1209	500	Woodgrain
1210	610	Woodgrain
1211	500	Stucco
1212	610	Stucco

EMBOSSING



COLORS

	9002	9010	9016 P	1015	6005	6009 P	7016 P	7016 M	7024 M	7035 P	7039 M	8014 P	9006	PGold	PLight	PDark	PMaha
500	●+	●+	●*	○	○	○	○	○*	○*	○*	○*	○	○+	○	○	○	○
610	●+	●+	●*	○			○	○*		○*		○	○+	○	○	○	○

● = Standard ○ = Option (min. 100 m²) * = Only in smooth + = Except in smooth

EPCO

YOUR NEEDS. OUR PANELS.

Fingersafe panel with single grooved outer sheet
 Available in heights 500, 553 and 610mm.
 Inner sheet ribbed, stucco embossed, RAL 9010.

PANEL SV

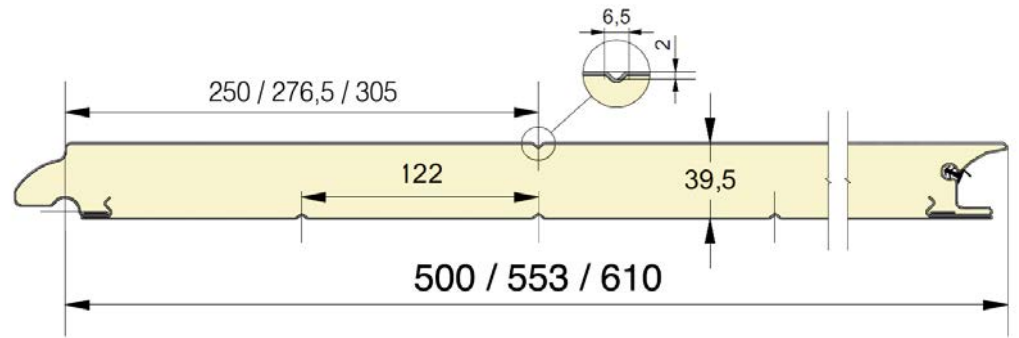

REFERENCE	HEIGHT	EMBOSSING
1225	500	Smooth
1284	553	Smooth
1226	610	Smooth
1229	500	Woodgrain
1285	553	Woodgrain
1230	610	Woodgrain
1233	500	Stucco
1286	553	Stucco
1233	610	Stucco

EMBOSSING



COLORS

	9002	9010	9016 P	1015	6005	6009 P	7016 P	7016 M	7024 M	7035 P	7039 M	8014 P	9006	PGold	PLight	PDark	PMaha
500	●+	●+	●*	○	○	○	○	○*	○*	○*	○*	○	○+	○	○	○	○
553		●+	●*				○	○*	○*		○*			○	○	○	○
610	●+	●+	●*	○			○	○*		○*		○	○+	○	○	○	○

● = Standard ○ = Option (min. 100 m²) * = Only in smooth + = Except in smooth

EPCO

YOUR NEEDS. OUR PANELS.

Fingersafe panel with 8mm micro ribbed outer sheet.
 Available in heights 500 and 610mm.
 Inner sheet: ribbed, stucco embossed, RAL 9010.

PANEL SM8

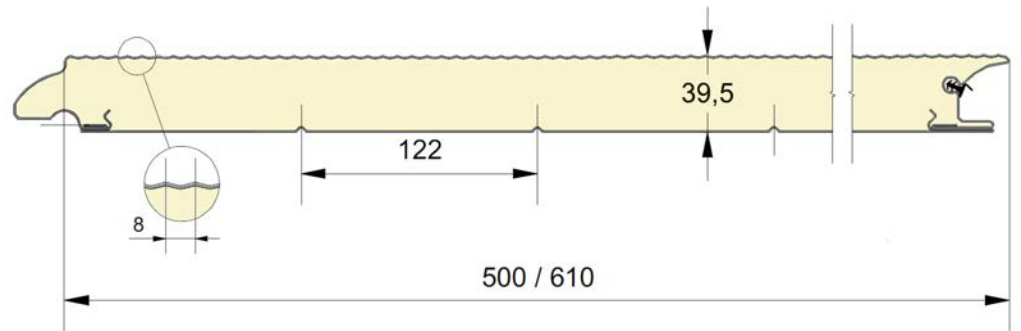

REFERENCE	HEIGHT	EMBOSSING
1213	500	Smooth
1214	610	Smooth

EMBOSSING



Smooth

COLORS

	9002	9016 P	1015	6005	6009 P	7016 P	7016 M	7024 M	7035 P	7039 M	8014 P	9006
500	●	●	○	○	○	○	○*	○*	○*	○*	○	○
610	●	●	○			○	○*		○*		○	○

● = Standard ○ = Option (min. 100 m²) * = Only in smooth + = Except in smooth

EPCO

YOUR NEEDS. OUR PANELS.

Fingersafe panel with 16mm micro ribbed outer sheet.
Available in heights 500 and 610mm.
Inner sheet: ribbed, stucco embossed, RAL 9010.

PANEL SM16

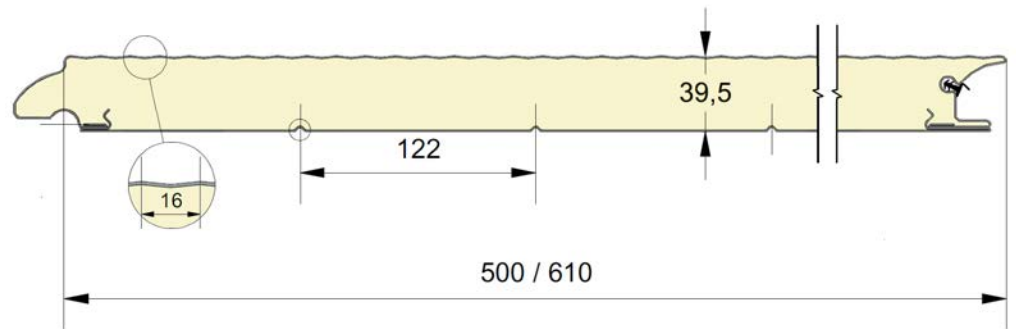

REFERENCE	HEIGHT	EMBOSSING
1219	500	Smooth
1220	610	Smooth

EMBOSSING



COLORS

	9002	9016 P	1015	6005	6009 P	7016 P	7016 M	7024 M	7035 P	7039 M	8014 P	9006
500	●	●	○	○	○	○	○*	○*	○*	○*	○	○
610	●	●	○			○	○*		○*		○	○

● = Standard ○ = Option (min. 100 m²) * = Only in smooth + = Except in smooth

EPCO

YOUR NEEDS. OUR PANELS.

Fingersafe panel with flat outer sheet
 Available in heights 500 and 610mm.
 Inner sheet : ribbed, stucco embossed, RAL 9010.

PANEL KF

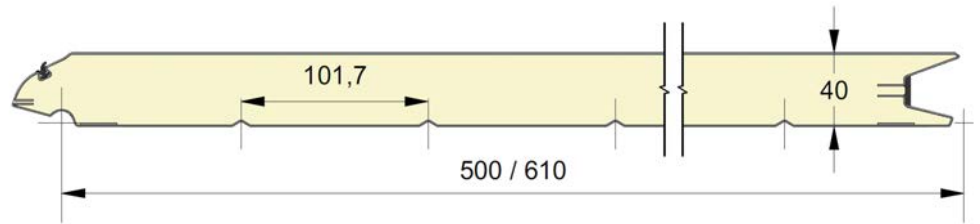

REFERENCE	HEIGHT	EMBOSSING
1501	500	Smooth
1502	610	Smooth
1503	500	Woodgrain
1504	610	Woodgrain
1505	500	Stucco
1506	610	Stucco

EMBOSSING



COLORS

	9010	9016 P	7016 P	7016 M	8014 P	9006	Golden Oak	Dark Oak	PGold	PLight	PDark	PMaha
500	○+	●*	●	○*	○	○+	○	○	○	○	○	○
610	○+	●*	●	○*	○	○+	○	○	○	○	○	○

● = Standard ○ = Option (min. 100 m²) * = Only in smooth + = Except in smooth

EPCO

YOUR NEEDS. OUR PANELS.

Fingersafe panel with ribbed outer sheet
 Available in heights 500 and 610mm.
 Inner sheet : ribbed, stucco embossed, RAL 9010.

PANEL KL

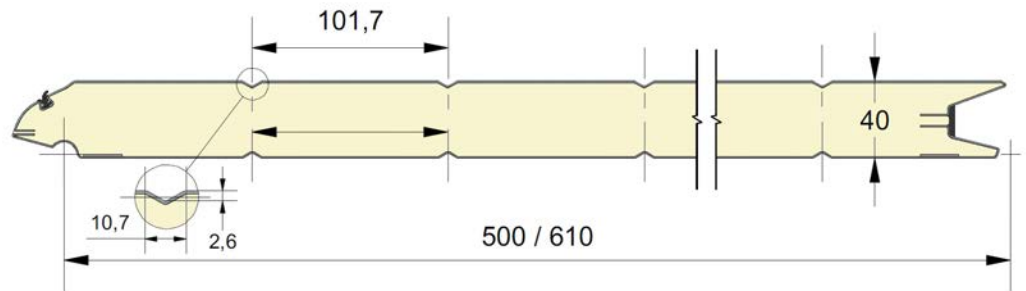

REFERENCE	HEIGHT	EMBOSSING
1507	500	Smooth
1508	610	Smooth
1509	500	Woodgrain
1510	610	Woodgrain
1511	500	Stucco
1512	610	Stucco

EMBOSSING



COLORS

	9010	9016 P	7016 P	7016 M	8014 P	9006	Golden Oak	Dark Oak	PGold	PLight	PDark	PMaha
500	○+	●*	●	○*	○	○+	○	○	○	○	○	○
610	○+	●*	●	○*	○	○+	○	○	○	○	○	○

● = Standard ○ = Option (min. 100 m²) * = Only in smooth + = Except in smooth

EPCO

YOUR NEEDS. OUR PANELS.

Fingersafe panel with 8mm micro ribbed outer sheet.
 Available in heights 500 and 610mm.
 Inner sheet: ribbed, stucco embossed, RAL 9010.

PANEL KM8

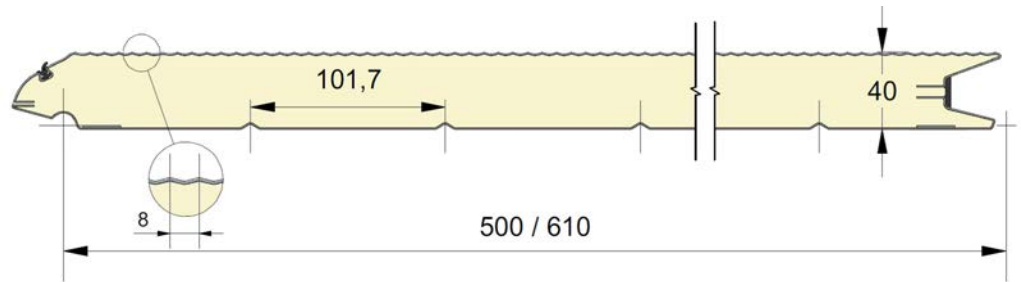

REFERENCE	HEIGHT	EMBOSSING
1513	500	Smooth
1514	610	Smooth

COLORS

	9016 P	7016 P	7016 M	9006
500	●	●	○	○
610	●	●	○	○

● = Standard ○ = Option (min. 100 m²)

EMBOSSING



EPCO

YOUR NEEDS. OUR PANELS.

Fingersafe panel with 16mm micro ribbed outer sheet.
 Available in heights 500 and 610mm.
 Inner sheet: ribbed, stucco embossed, RAL 9010.

PANEL KM16

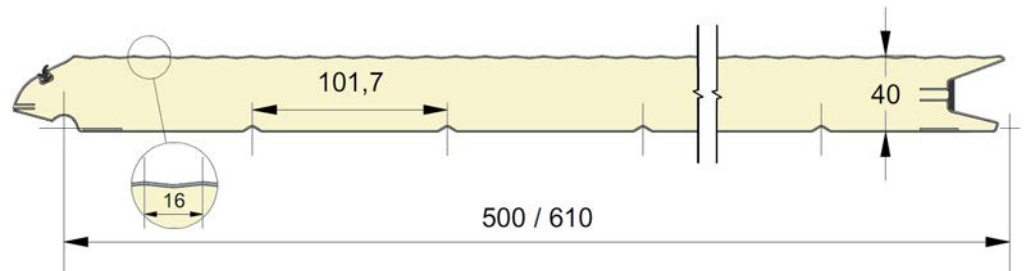

REFERENCE	HEIGHT	EMBOSSING
1519	500	Smooth
1520	610	Smooth

COLORS

	9016 P	7016 P	7016 M	9006
500	●	●	○	○
610	●	●	○	○

● = Standard ○ = Option (min. 100 m²)

EMBOSSING



EPCO

YOUR NEEDS. OUR PANELS.

Fingersafe panel with single grooved outer sheet
 Available in heights 500 and 610mm with groove centered, up or down.
 Inner sheet ribbed, stucco embossed, RAL 9010.

PANEL KV

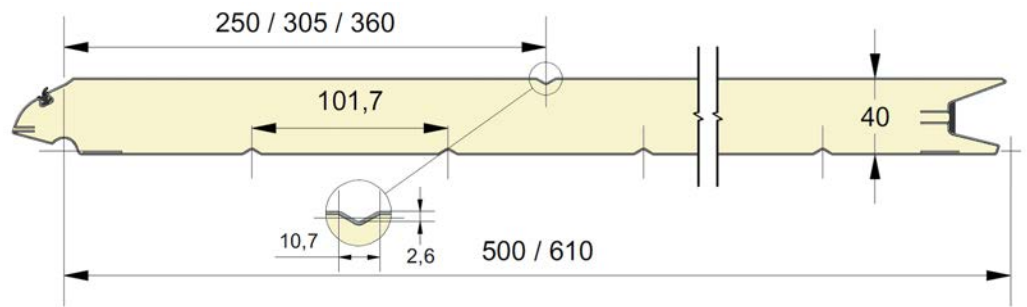

REFERENCE	HEIGHT	EMBOSSING
1525	500	Smooth
1526	610 CN	Smooth
1527	610 UP	Smooth
1528	610 DN	Smooth
1529	500	Woodgrain
1530	610 CN	Woodgrain
1531	610 UP	Woodgrain
1532	610 DN	Woodgrain
1533	500	Stucco
1534	610 CN	Stucco
1535	610 UP	Stucco
1536	610 DN	Stucco

EMBOSSING

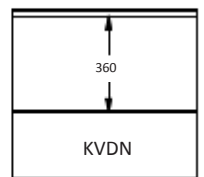
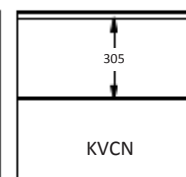
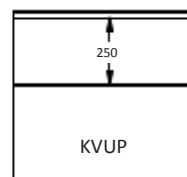
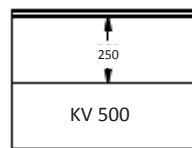

COLORS

	9010	9016 P	7016 P	7016 M	8014 P	9006	Golden Oak	Dark Oak	PGold	PLight	PDark	PMaha
500	○+	●*	●	○*	○	○+	○	○	○	○	○	○
610	○+	●*	●	○*	○	○+	○	○	○	○	○	○

● = Standard ○ = Option (min. 100 m²) * = Only in smooth + = Except in smooth

EPCO

YOUR NEEDS. OUR PANELS.

Fingersafe panel with top grooved outer sheet
 Available in heights 500 and 610mm with groove centered, up or down.
 Inner sheet ribbed, stucco embossed, RAL 9010.

PANEL KT

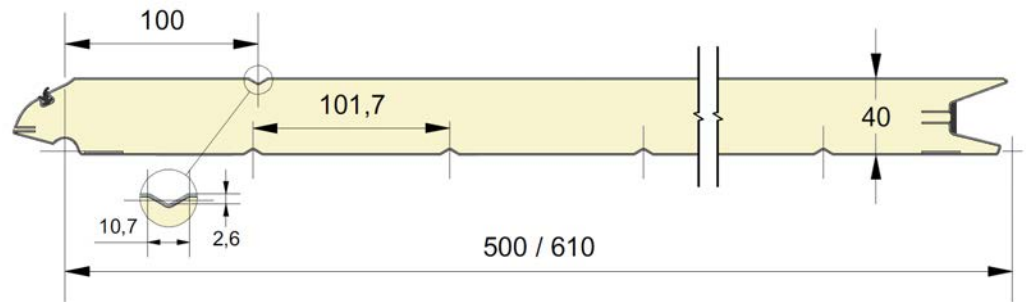

REFERENCE	HEIGHT	EMBOSSING
1590	500	Smooth
1592	610	Smooth
1593	500	Woodgrain
1595	610	Woodgrain
1596	500	Stucco
1598	610	Stucco

EMBOSSING



COLORS

	9010	9016 P	7016 P	7016 M	8014 P	9006	Golden Oak	Dark Oak	PGold	PLight	PDark	PMaha
500	○+	●*	●	○*	○	○+	○	○	○	○	○	○
610	○+	●*	●	○*	○	○+	○	○	○	○	○	○

● = Standard ○ = Option (min. 100 m²) * = Only in smooth + = Except in smooth

EPCO

YOUR NEEDS. OUR PANELS.

Fingersafe panel with raised cassette in outer sheet
 Available in heights 500 and 610mm with cassette centered, up or down.
 Inner sheet : ribbed, stucco embossed, RAL 9010.

PANEL KC

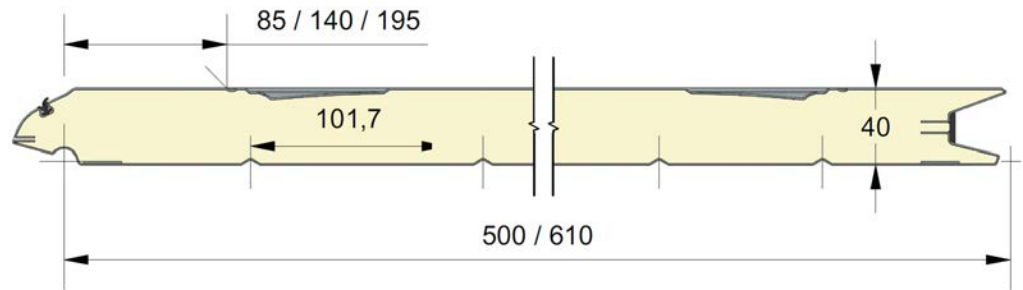

REFERENCE	HEIGHT	EMBOSSING
1537	500	Smooth
1538	610 CN	Smooth
1539	610 UP	Smooth
1540	610 DN	Smooth
1541	500	Woodgrain
1542	610 CN	Woodgrain
1543	610 UP	Woodgrain
1544	610 DN	Woodgrain
1545	500	Stucco
1546	610 CN	Stucco
1547	610 UP	Stucco
1548	610 DN	Stucco

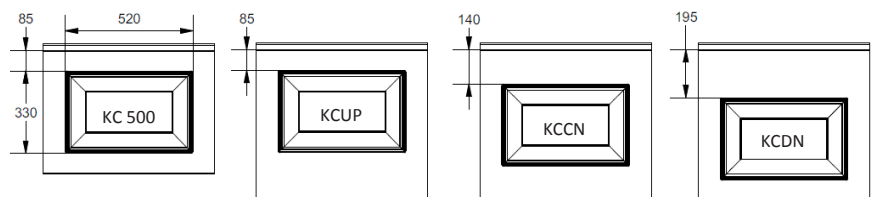

COLORS

	9010	9016 P	8014 P	Golden Oak	Dark Oak	PGold	PLight	PDark	PMaha
500 BOIS	●		○	○	○	○	○	○	○
610 BOIS	●		○	○	○	○	○	○	○
500 LISSE		○		○	○	○	○	○	○
610 LISSE		○		○	○	○	○	○	○

● = Standard ○ = Option (min. 100 m²)

EMBOSSING



EPCO

YOUR NEEDS. OUR PANELS.

Fingersafe panel with flat outer sheet
 Available in heights 500 and 610mm.
 Inner sheet : ribbed, stucco embossed, RAL 9010.

PANEL LF

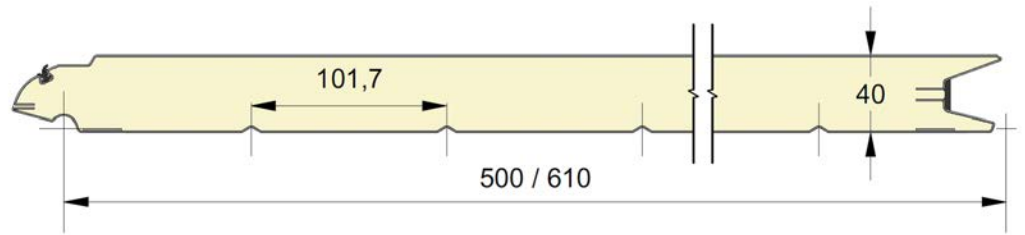

REFERENCE	HEIGHT	EMBOSSING
1601	500	Smooth
1602	610	Smooth
1603	500	Woodgrain
1604	610	Woodgrain
1605	500	Stucco
1606	610	Stucco

EMBOSSING



COLORS

	9010	9016 P	7016 P	7016 M	8014 P	9006	Golden Oak	Dark Oak	PGold	PLight	PDark	PMaha
500	○+	●*	●	○*	○	○+	○	○	○	○	○	○
610	○+	●*	●	○*	○	○+	○	○	○	○	○	○

● = Standard ○ = Option (min. 100 m²) * = Only in smooth + = Except in smooth

EPCO

YOUR NEEDS. OUR PANELS.

Fingersafe panel with single grooved outer sheet
 Available in heights 500 and 610mm with groove centered, up or down.
 Inner sheet ribbed, stucco embossed, RAL 9010.

PANEL LU

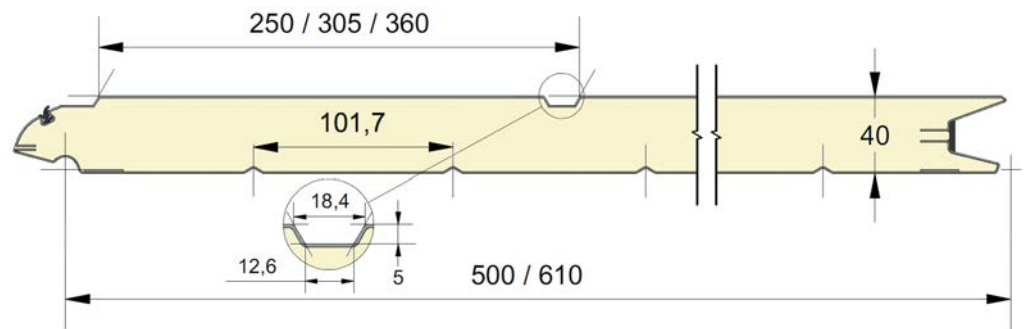

REFERENCE	HEIGHT	EMBOSSING
1607	500	Smooth
1608	610 CN	Smooth
1609	610 UP	Smooth
1610	610 DN	Smooth
1611	500	Woodgrain
1612	610 CN	Woodgrain
1613	610 UP	Woodgrain
1614	610 DN	Woodgrain
1615	500	Stucco
1616	610 CN	Stucco
1617	610 UP	Stucco
1618	610 DN	Stucco

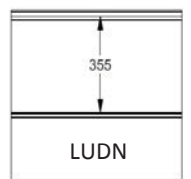
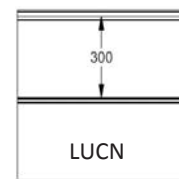
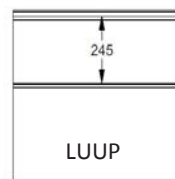
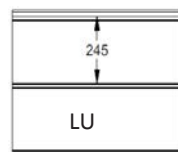

EMBOSSING



COLORS

	9010	9016 P	7016 P	7016 M	8014 P	9006	Golden Oak	Dark Oak	PGold	PLight	PDark	PMaha
500	○+	●*	●	○*	○	○+	○	○	○	○	○	○
610	○+	●*	●	○*	○	○+	○	○	○	○	○	○

● = Standard ○ = Option (min. 100 m²) * = Only in smooth + = Except in smooth

EPCO

YOUR NEEDS. OUR PANELS.

Fingersafe panel with 8mm micro ribbed outer sheet.
 Available in heights 500 and 610mm.
 Inner sheet: ribbed, stucco embossed, RAL 9010.

PANEL LM8

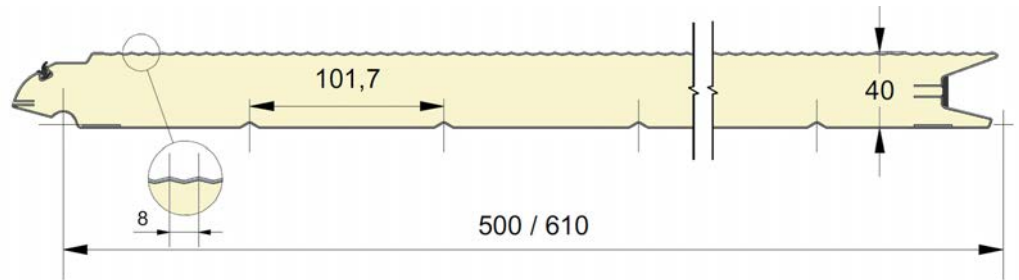

REFERENCE	HEIGHT	EMBOSSING
1619	500	Smooth
1620	610	Smooth

COLORS

	9016 P	7016 P	7016 M	9006
500	●	●	○	○
610	●	●	○	○

● = Standard ○ = Option (min. 100 m²)

EMBOSSING



EPCO

YOUR NEEDS. OUR PANELS.

Fingersafe panel with 16mm micro ribbed outer sheet.
 Available in heights 500 and 610mm.
 Inner sheet: ribbed, stucco embossed, RAL 9010.

PANEL LM16

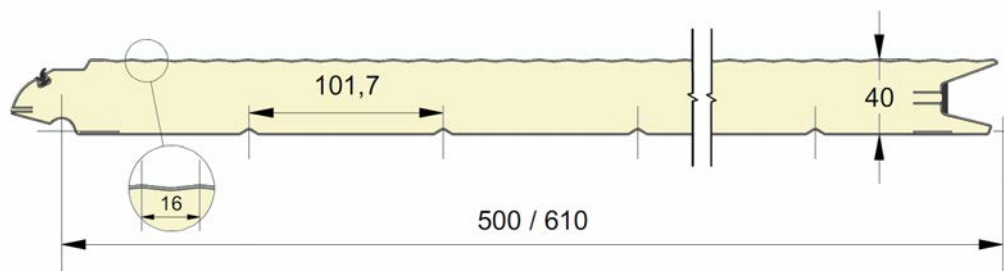

REFERENCE	HEIGHT	EMBOSSING
1649	500	Smooth
1650	610	Smooth

COLORS

	9016 P	7016 P	7016 M	9006
500	●	●	○	○
610	●	●	○	○

● = Standard ○ = Option (min. 100 m²)

EMBOSSING



EPCO

YOUR NEEDS. OUR PANELS.

Fingersafe panel with single grooved and 8mm micro ribbed outer sheet.
 Available in heights 500 and 610mm.
 Inner sheet: ribbed, stucco embossed, RAL 9010.

PANEL LUM8

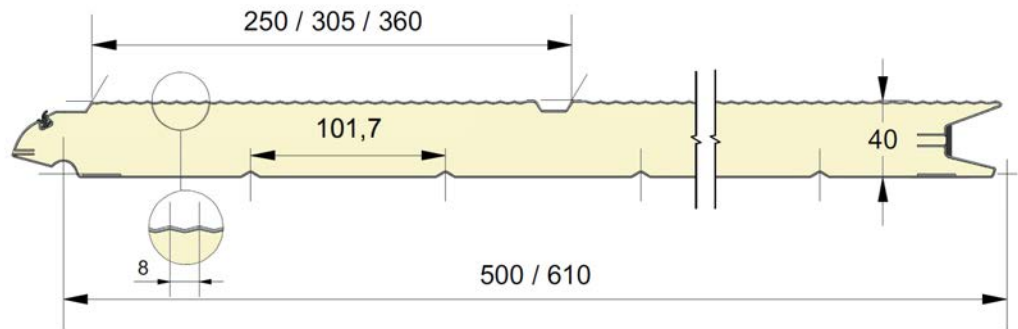

REFERENCE	HEIGHT	EMBOSSING
1621	500	Smooth
1622	610 CN	Smooth
1623	610 UP	Smooth
1624	610 DN	Smooth

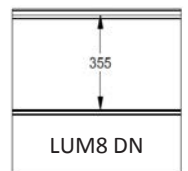
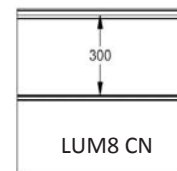
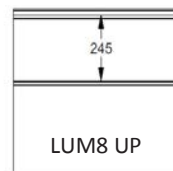
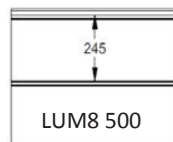

COLORS

	9016 P	7016 P	7016 M	9006
500	●	●	○	○
610	●	●	○	○

● = Standard ○ = Option (min. 100 m²)

EMBOSSING



EPCO

YOUR NEEDS. OUR PANELS.

Fingersafe panel with single grooved and 16mm micro ribbed outer sheet.
 Available in heights 500 and 610mm.
 Inner sheet: ribbed, stucco embossed, RAL 9010.

PANEL LUM16

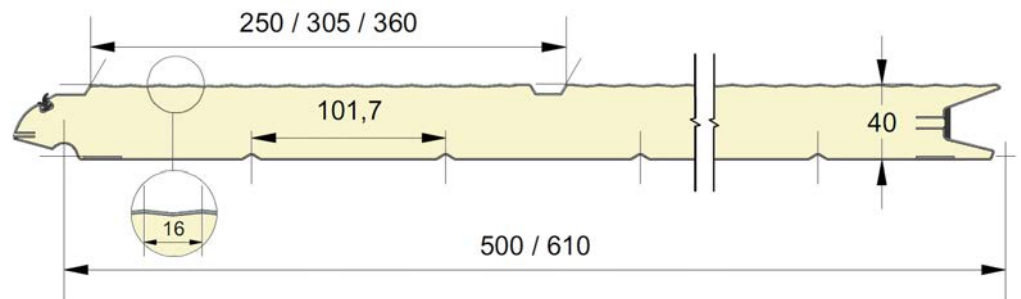

REFERENCE	HEIGHT	EMBOSSING
1651	500	Smooth
1652	610 CN	Smooth
1653	610 UP	Smooth
1654	610 DN	Smooth

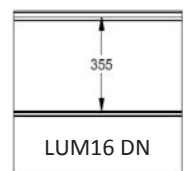
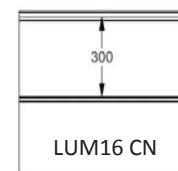
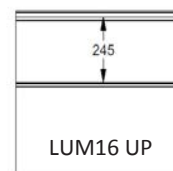
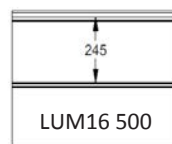

COLORS

	9016 P	7016 P	7016 M	9006
500	●	●	○	○
610	●	●	○	○

● = Standard ○ = Option (min. 100 m²)

EMBOSSING



EPCO

YOUR NEEDS. OUR PANELS.

Fingersafe panel with upper grooved outer sheet.
Available in heights 500 and 610mm.
Inner sheet: ribbed, stucco embossed, RAL 9010.

PANEL LT

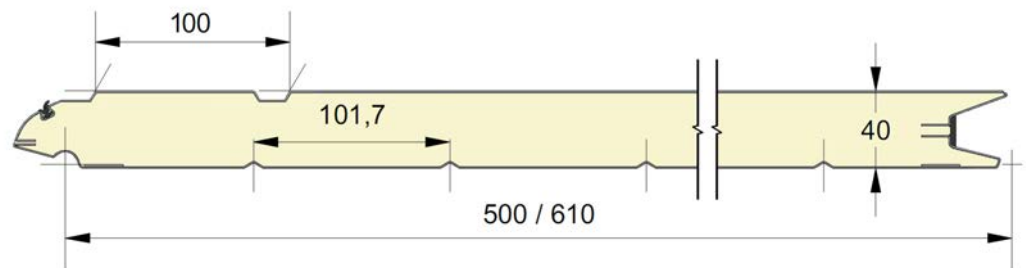

REFERENCE	HEIGHT	EMBOSSING
1677	500	Smooth
1679	610	Smooth
1680	500	Woodgrain
1682	610	Woodgrain
1683	500	Stucco
1685	610	Stucco

EMBOSSING



COLORS

	9010	9016 P	7016 P	7016 M	8014 P	9006	Golden Oak	Dark Oak	PGold	PLight	PDark	PMaha
500	○+	●*	●	○*	○	○+	○	○	○	○	○	○
610	○+	●*	●	○*	○	○+	○	○	○	○	○	○

● = Standard ○ = Option (min. 100 m²) ●* = Only in smooth ○+ = Except in smooth

EPCO

YOUR NEEDS. OUR PANELS.

20mm fingersafe panel with flat outer sheet.
 Available in heights 500 and 555mm.
 Inner sheet ribbed, stucco, RAL 9010.

PANEL **CF**

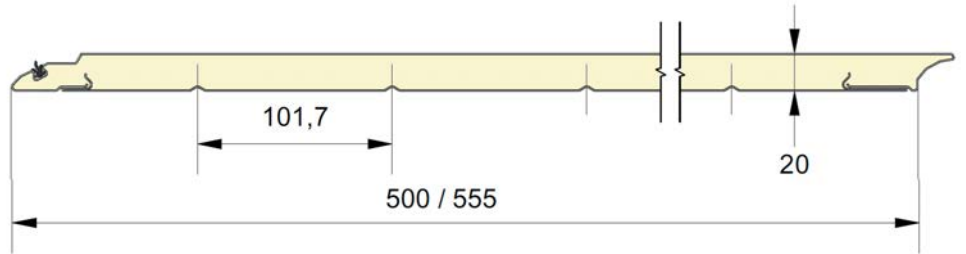

REFERENCE	HEIGHT	EMBOSSING
1801	500	Smooth
1802	555	Smooth
1803	500	Woodgrain
1804	555	Woodgrain
1805	500	Stucco
1806	555	Stucco

COLORS

	9010	9016 P	7016 P
500	○+	●*	○
555	○+	●*	○

EMBOSSING



● = Standard ○ = Option (min. 100 m²) * = Only in smooth + = Except in smooth

EPCO

YOUR NEEDS. OUR PANELS.

20mm fingersafe panel with grooved outer sheet.
 Available in heights 500 and 555mm.
 Inner sheet ribbed, stucco, RAL 9010.

PANEL CU

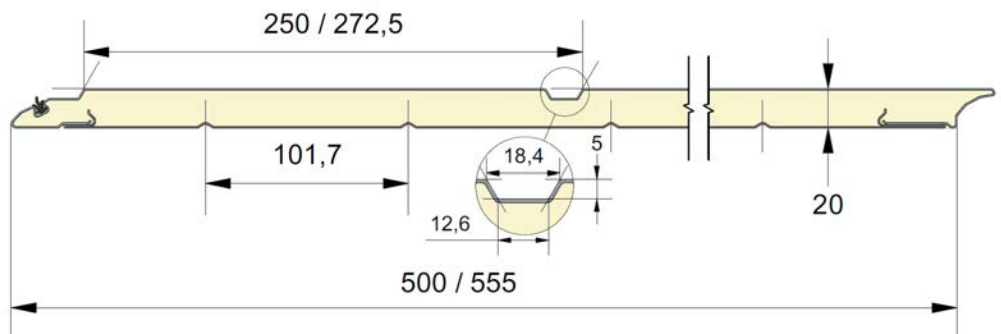

REFERENCE	HEIGHT	EMBOSSING
1807	500	Smooth
1808	555	Smooth
1809	500	Woodgrain
1810	555	Woodgrain
1811	500	Stucco
1812	555	Stucco

COLORS

	9010	9016 P	7016 P
500	○+	●*	○
555	○+	●*	○

● = Standard ○ = Option (min. 100 m²) * = Only in smooth + = Except in smooth

EMBOSSING



EPCO

YOUR NEEDS. OUR PANELS.

20mm fingersafe panel with 8mm microribbed outer sheet.
 Available in heights 500 and 555mm.
 Inner sheet ribbed, stucco, RAL 9010.

PANEL CM8

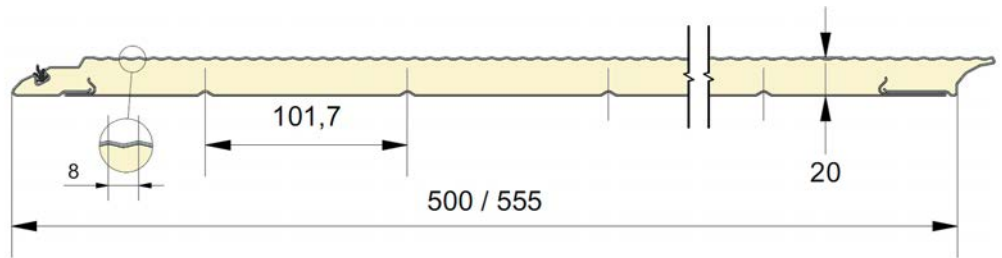

REFERENCE	HEIGHT	EMBOSSING
1813	500	Smooth
1814	555	Smooth

COLORS

	9016 P	7016 P
500	<input checked="" type="radio"/>	<input type="radio"/>
555	<input checked="" type="radio"/>	<input type="radio"/>

= Standard = Option (min. 100 m²)

EMBOSSING



EPCO

YOUR NEEDS. OUR PANELS.

20mm fingersafe panel with 16mm microribbed outer sheet.
 Available in heights 500 and 555mm.
 Inner sheet ribbed, stucco, RAL 9010.

PANEL CM16

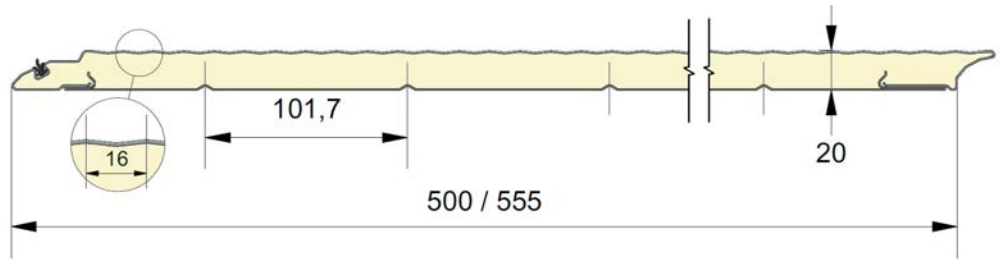

REFERENCE	HEIGHT	EMBOSSING
1815	500	Smooth
1816	555	Smooth

COLORS

	9016 P	7016 P
500	<input checked="" type="radio"/>	<input type="radio"/>
555	<input checked="" type="radio"/>	<input type="radio"/>

= Standard = Option (min. 100 m²)

EMBOSSING



EPCO

YOUR NEEDS. OUR PANELS.

20mm fingersafe panel with grooved and 8mm microribbed outer sheet.
 Available in heights 500 and 555mm.
 Inner sheet ribbed, stucco, RAL 9010.

PANEL CUM8

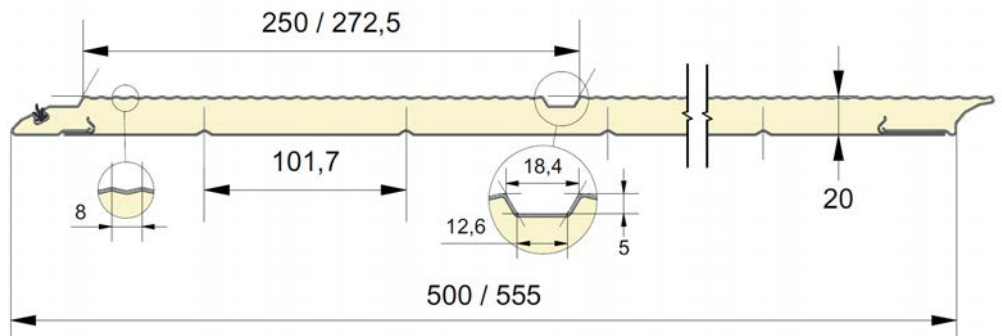

REFERENCE	HEIGHT	EMBOSSING
1817	500	Smooth
1818	555	Smooth

COLORS

	9016 P	7016 P
500	<input checked="" type="radio"/>	<input type="radio"/>
555	<input checked="" type="radio"/>	<input type="radio"/>

= Standard = Option (min. 100 m²)

EMBOSSING



EPCO

YOUR NEEDS. OUR PANELS.

20mm fingersafe panel with grooved and 16mm microribbed outer sheet.
 Available in heights 500 and 555mm.
 Inner sheet ribbed, stucco, RAL 9010.

PANEL CUM16

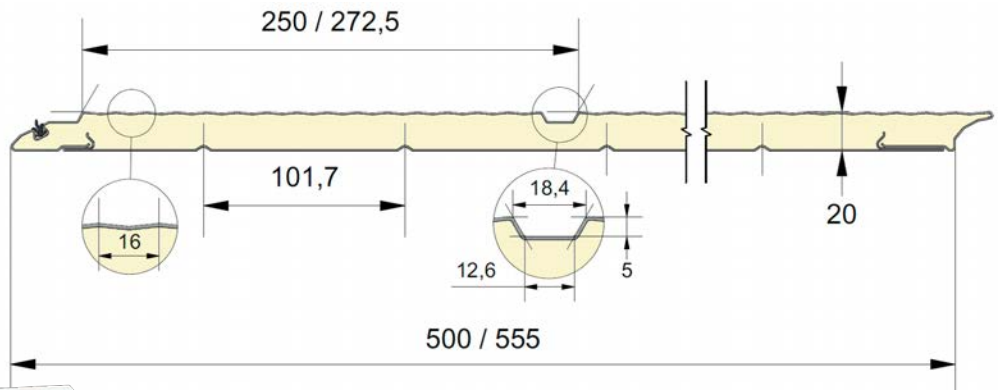

REFERENCE	HEIGHT	EMBOSSING
1819	500	Smooth
1820	555	Smooth

COLORS

	9016 P	7016 P
500	<input checked="" type="radio"/>	<input type="radio"/>
555	<input checked="" type="radio"/>	<input type="radio"/>

= Standard = Option (min. 100 m²)

EMBOSSING



EPCO

YOUR NEEDS. OUR PANELS.