

Industrietorpaneel mit ebener Außenseite.  
Erhältlich in den Höhen 488, 610 und 732 mm.  
Innenseite liniert, glatt, RAL 9002.

# PANEEL HF

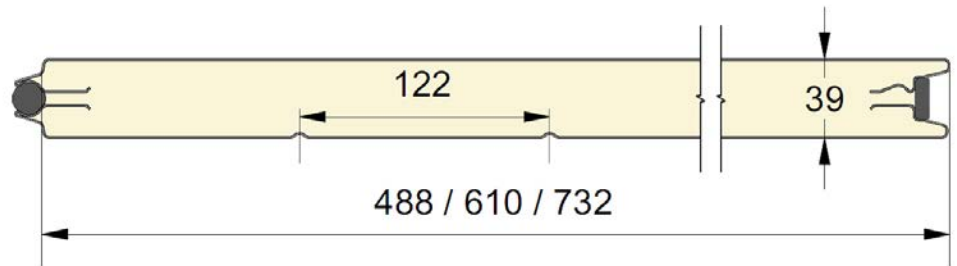

ARTIKELNR.	HÖHE	PRÄGUNG
401	488	Glatt
402	610	Glatt
403	732	Glatt
404	488	Stucco
405	610	Stucco
406	732	Stucco

## PRÄGUNG



## FARBE

	9002	9010	1021	3000	5003 P	5010 P	6009 P	7005	7044	7016 P	8014 P	9006	9007
488	●									○		○	
610	●	●	○	○	○	○	○	○	○	●	○	●	●
732	●									○		○	

● = Standard    ○ = Option (mind. 100 m<sup>2</sup>)

**EPCO**

YOUR NEEDS. OUR PANELS.

Industrietorpaneel mit liniertes Außenseite.  
Erhältlich in den Höhen 488, 610 und 732 mm.  
Innenseite liniert, glatt, RAL 9002.

# PANEEL HL

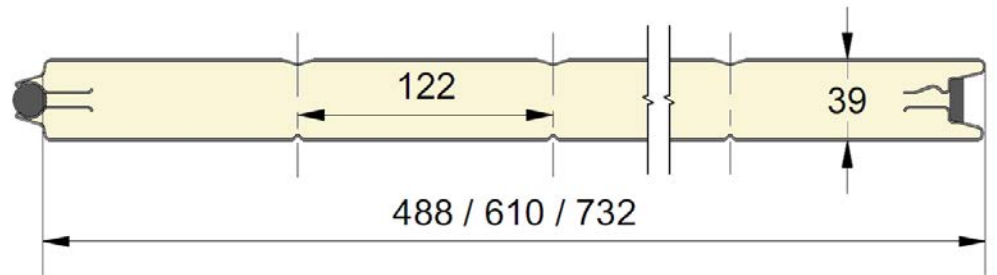

ARTIKELNR.	HÖHE	PRÄGUNG
407	488	Glatt
408	610	Glatt
409	732	Glatt
410	488	Stucco
411	610	Stucco
412	732	Stucco

## PRÄGUNG



## FARBE

	9002	9010	1021	3000	5003 P	5010 P	6009 P	7005	7044	7016 P	8014 P	9006	9007
488	●									○		○	
610	●	●	○	○	○	○	○	○	○	●	○	●	●
732	●									○		○	

● = Standard    ○ = Option (mind. 100 m<sup>2</sup>)

**EPCO**

YOUR NEEDS. OUR PANELS.

Industrietorpaneel met microlinierte Außenseite.  
Erhältlich in den Höhen 488, 610 und 732 mm.  
Innenseite liniert, glatt, RAL 9002.

# PANEEL **HM8**

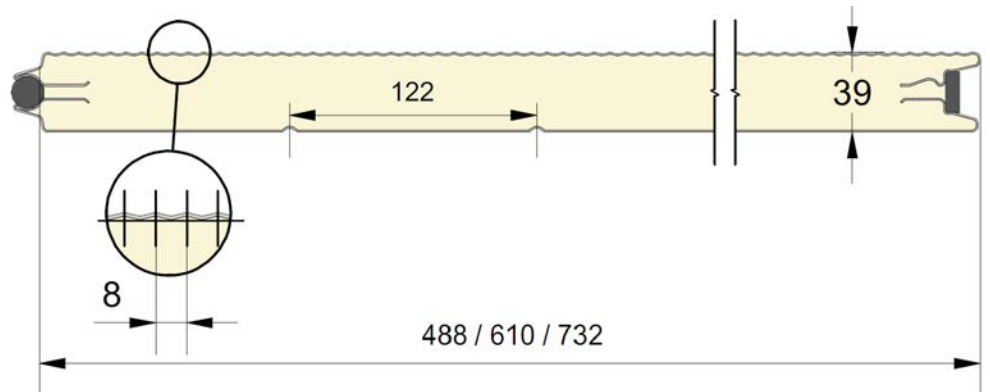

ARTIKELNR.	HÖHE	PRÄGUNG
413	488	Glatt
414	610	Glatt
415	732	Glatt

## PRÄGUNG



## FARBE

	9002	9010	1021	3000	5003 P	5010 P	6009 P	7005	7044	7016 P	8014 P	9006	9007
488	●									○		○	
610	●	●	○	○	○	○	○	○	○	●	○	●	●
732	●									○		○	

● = Standard ○ = Option (mind. 100 m<sup>2</sup>)

**EPCO**

YOUR NEEDS. OUR PANELS.

Industrietorpaneel met ebener Außenseite.  
Erhältlich in den Höhen 500 und 610 mm.  
Innenseite liniert, stucco-geprägt, RAL 9002.

# PANEEL **IF**

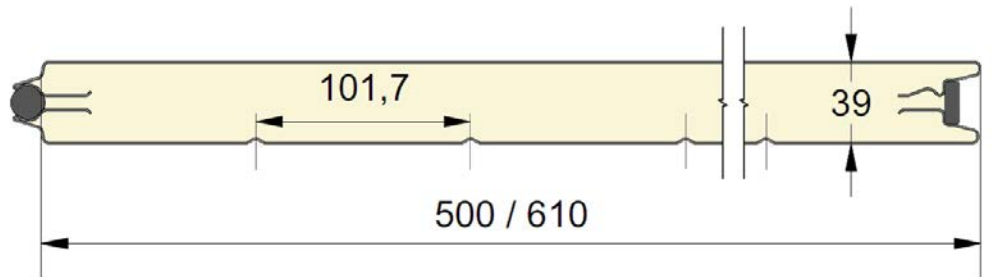

ARTIKELNR.	HÖHE	PRÄGUNG
303	500	Stucco
304	610	Stucco

## PRÄGUNG



## FARBE

	9002	9010	1021	3000	5003 P	5010 P	6009 P	7005	7044	7016 P	8014 P	9006	9007
500	○	●	○	○	○	○	○	○	○	○	○	○	○
610	○	●	○	○	○	○	○	○	○	○	○	○	○

● = Standard    ○ = Option (mind. 100 m<sup>2</sup>)

**EPCO**

YOUR NEEDS. OUR PANELS.

Industrietorpaneel mit liniertes Außenseite.  
Erhältlich in den Höhen 500 und 610 mm.  
Innenseite liniert, stucco-geprägt, RAL 9002.

# PANEEL **IL**

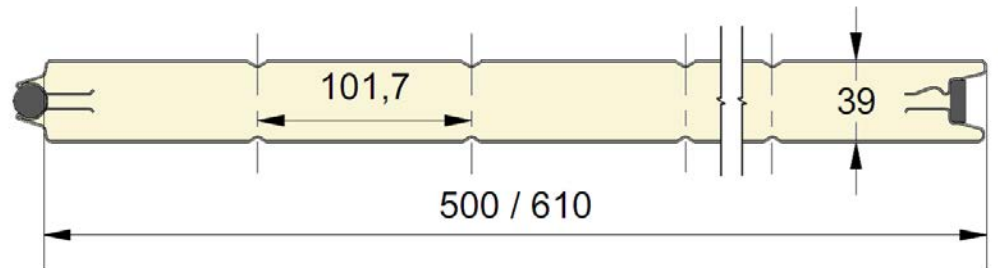

ARTIKELNR.	HÖHE	PRÄGUNG
307	500	Stucco
308	610	Stucco

## PRÄGUNG



## FARBE

	9002	9010	1021	3000	5003 P	5010 P	6009 P	7005	7044	7016 P	8014 P	9006	9007
500	<input type="radio"/>	<input checked="" type="radio"/>	<input type="radio"/>	<input type="radio"/>	<input type="radio"/>	<input type="radio"/>	<input type="radio"/>	<input type="radio"/>	<input type="radio"/>	<input type="radio"/>	<input type="radio"/>	<input type="radio"/>	<input type="radio"/>
610	<input type="radio"/>	<input checked="" type="radio"/>	<input type="radio"/>	<input type="radio"/>	<input type="radio"/>	<input type="radio"/>	<input type="radio"/>	<input type="radio"/>	<input type="radio"/>	<input type="radio"/>	<input type="radio"/>	<input type="radio"/>	<input type="radio"/>

= Standard     = Option (mind. 100 m<sup>2</sup>)

**EPCO**

YOUR NEEDS. OUR PANELS.

Industrietorpaneel met 8mm microlinierte Außenseite.  
 Erhältlich in den Höhen 500 und 610 mm.  
 Innenseite liniert, stucco-geprägt, RAL 9002.

# PANEEL IM8

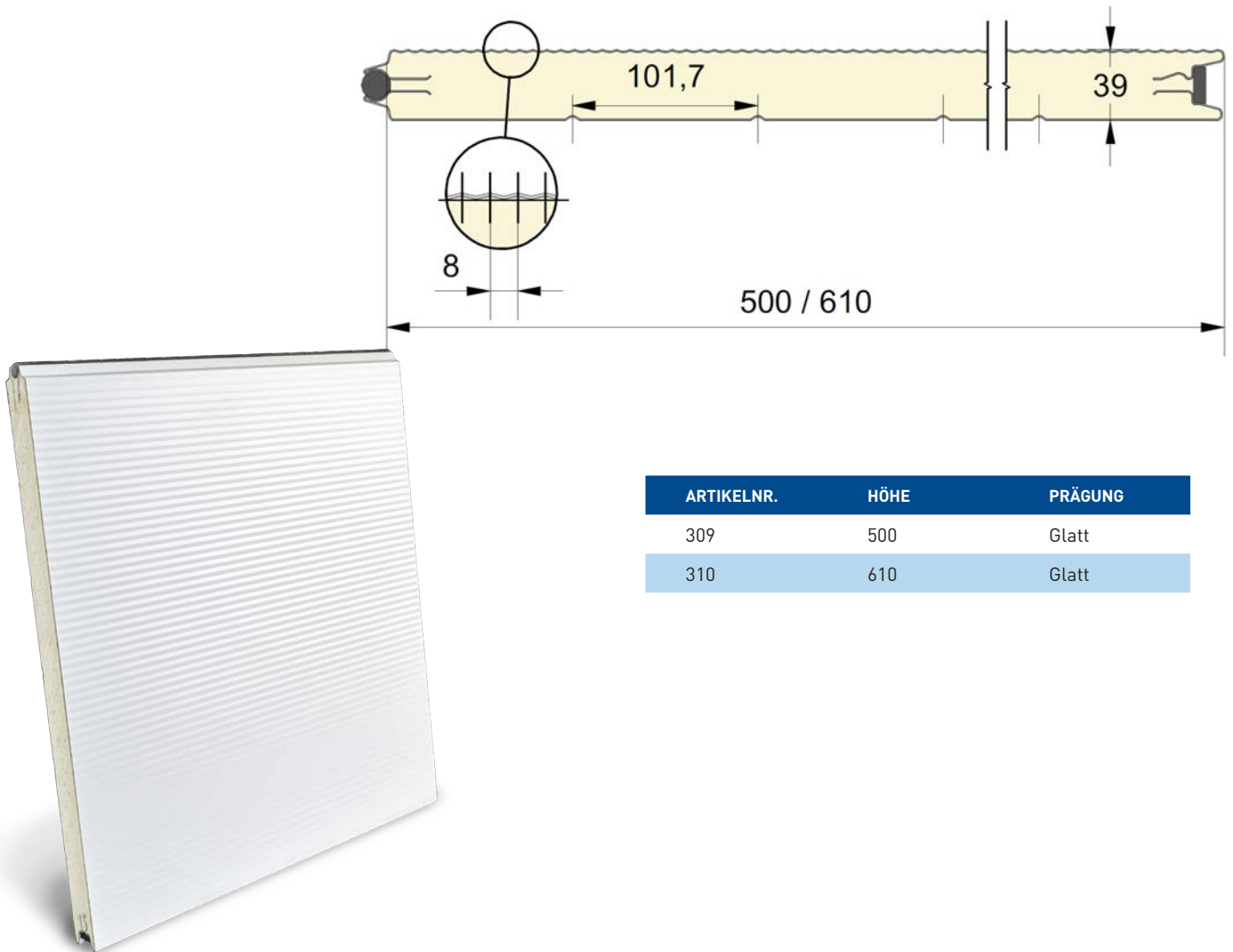

ARTIKELNR.	HÖHE	PRÄGUNG
309	500	Glatt
310	610	Glatt

## PRÄGUNG



Glatt

## FARBE

	9002	9010	1021	3000	5003 P	5010 P	6009 P	7005	7044	7016 P	8014 P	9006	9007
500	<input type="radio"/>	<input checked="" type="radio"/>	<input type="radio"/>	<input type="radio"/>	<input type="radio"/>	<input type="radio"/>	<input type="radio"/>	<input type="radio"/>	<input type="radio"/>	<input type="radio"/>	<input type="radio"/>	<input type="radio"/>	<input type="radio"/>
610	<input type="radio"/>	<input checked="" type="radio"/>	<input type="radio"/>	<input type="radio"/>	<input type="radio"/>	<input type="radio"/>	<input type="radio"/>	<input type="radio"/>	<input type="radio"/>	<input type="radio"/>	<input type="radio"/>	<input type="radio"/>	<input type="radio"/>

= Standard     = Option (mind. 100 m<sup>2</sup>)

**EPCO**

YOUR NEEDS. OUR PANELS.



Industrietorpaneel mit 16mm microliniertes Außenseite.  
 Erhältlich in den Höhen 500 und 610 mm.  
 Innenseite liniert, stucco-geprägt, RAL 9002.

# PANEEL IM16

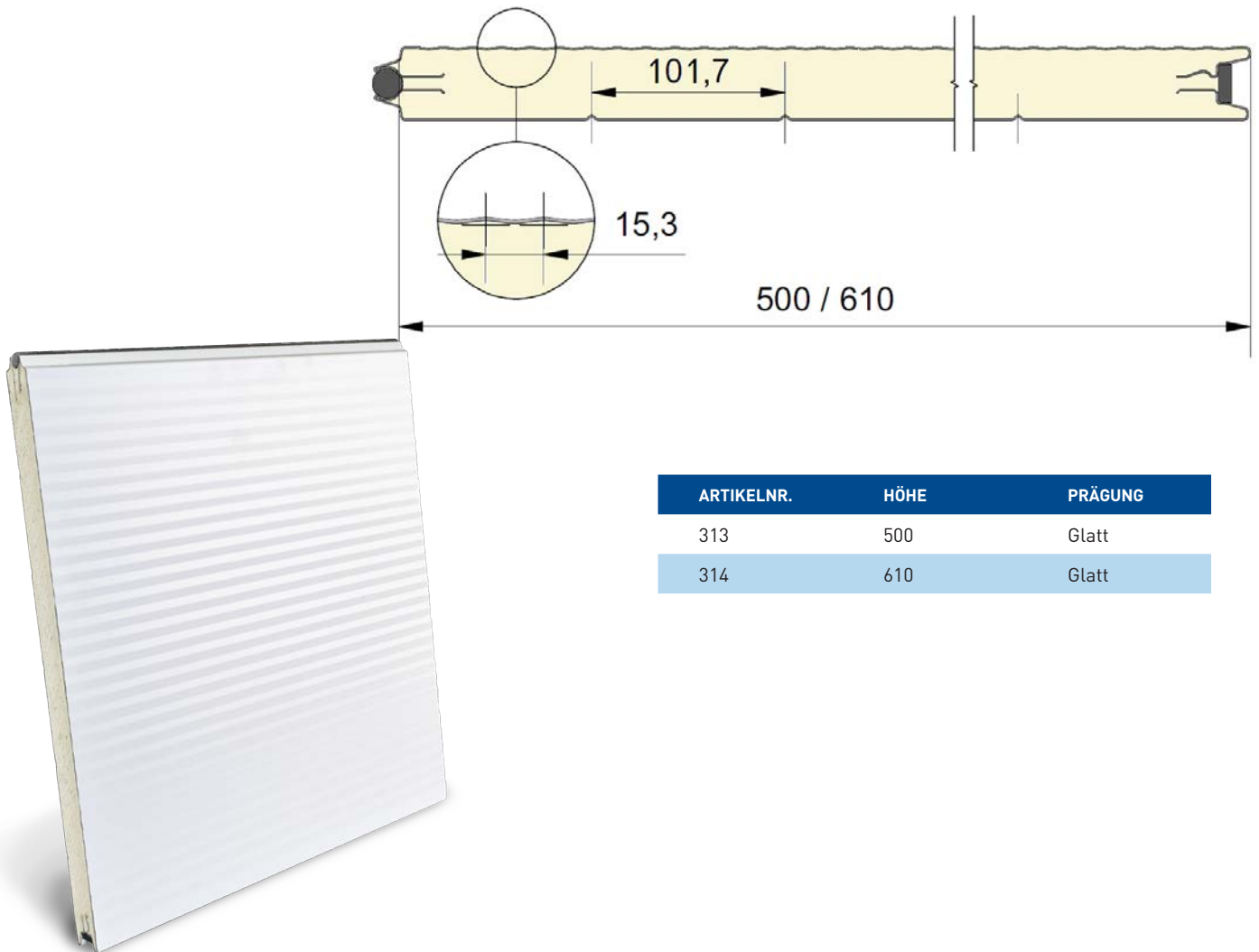

ARTIKELNR.	HÖHE	PRÄGUNG
313	500	Glatt
314	610	Glatt

## PRÄGUNG



## FARBE

	9002	9010	1021	3000	5003 P	5010 P	6009 P	7005	7044	7016 P	8014 P	9006	9007
500	○	●	○	○	○	○	○	○	○	○	○	○	○
610	○	●	○	○	○	○	○	○	○	○	○	○	○

● = Standard    ○ = Option (mind. 100 m<sup>2</sup>)

**EPCO**

YOUR NEEDS. OUR PANELS.

60mm Industrietorpaneel mit liniertes Außenseite.  
Erhältlich in Höhe 610 mm.  
Innenseite liniert, Glatt, RAL 9002.

# PANEEL XL

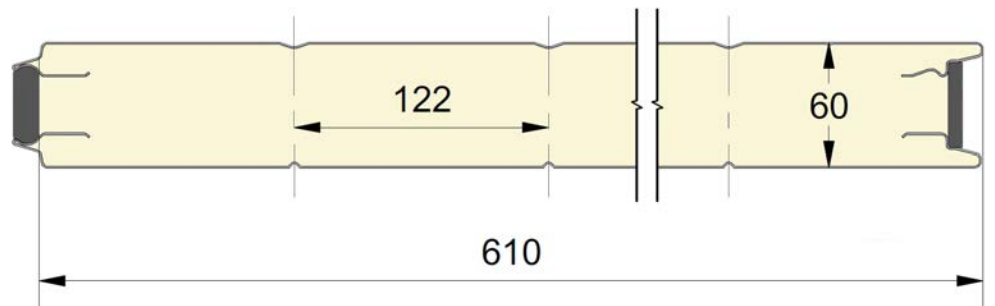

ARTIKELNR.	HÖHE	PRÄGUNG
608	610	Glatt
611	610	Stucco

## PRÄGUNG

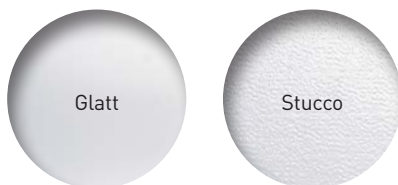

## FARBE

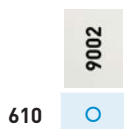

● = Standard ○ = Option (mind. 100 m<sup>2</sup>)

**EPCO**

YOUR NEEDS. OUR PANELS.



80mm Industrietorpaneel mit liniertes Außenseite.  
 Erhältlich in den Höhen 488 und 610 mm.  
 Innenseite liniert, stucco-geprägt, RAL 9002.

# PANEEL ZL

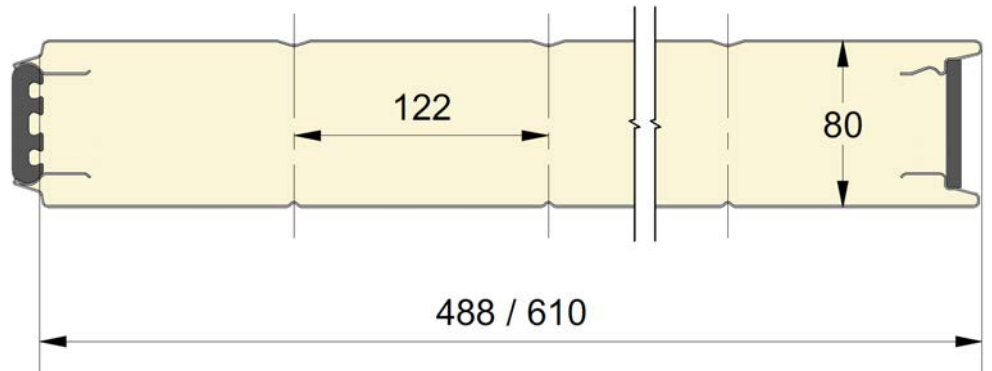

ARTIKELNR.	HÖHE	PRÄGUNG
510	488	Stucco
511	610	Stucco

## PRÄGUNG



## FARBE

	9002	9010	1021	3000	5003 P	5010 P	6009 P	7005	7044	7016 P	8014 P	9006	9007
488	○									○		○	
610	○	○	○	○	○	○	○	○	○	○	○	○	○

● = Standard ○ = Option (mind. 100 m<sup>2</sup>)

**EPCO**

YOUR NEEDS. OUR PANELS.

Fingerschutzpaneel mit ebener Außenseite.  
Erhältlich in den Höhen 500, 555 und 610 mm.  
Innenseite liniert, stucco-geprägt, RAL 9010.

# PANEEL RF

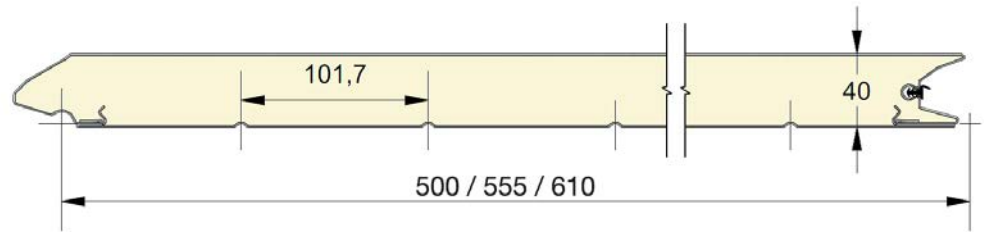

ARTIKELNR.	HÖHE	PRÄGUNG
001	500	Glatt
073	555	Glatt
002	610	Glatt
003	500	Holz
074	555	Holz
004	610	Holz
005	500	Stucco
075	555	Stucco
006	610	Stucco

## PRÄGUNG



## COLORS

	9010	9016 P	1015	6005	6009 P	7016 P	7016 M	7024 M	7035 P	7039 M	8014 P	9006	Goldene Eiche	Dunkel Eiche	Mahogany	Rustikal Eiche	Weisse Eiche	Anthracite	PGold	PLight	PDark	PMaha
500	●+	●*	○	○	○	●	●*	○*	○	●*	○	○+	●	●	○	○	○*	○*	○	○	○	○
555	●+	●*				●	○*	○*		○*			●	○					○	○	○	○
610	●+	●*	○			●	●*		○		○	○+	●	●	○	○			○	○	○	○

● = Standard    ○ = Option (mind. 100 m<sup>2</sup>)    \* = Nur in glatt    + = Außer in glatt

# EPCO

YOUR NEEDS. OUR PANELS.

Fingerschutzpaneel mit liniertes Außenseite.  
Erhältlich in den Höhen 500 und 610 mm.  
Innenseite liniert, stucco-geprägt, RAL 9010.

# PANEEL RL

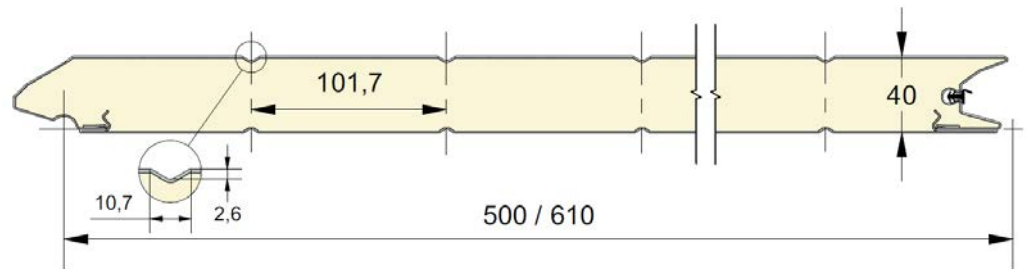

ARTIKELNR.	HÖHE	PRÄGUNG
007	500	Glatt
008	610	Glatt
009	500	Holz
010	610	Holz
011	500	Stucco
012	610	Stucco

## PRÄGUNG



## COLORS

	9010	9016 P	1015	6005	6009 P	7016 P	7016 M	7024 M	7035 P	7039 M	8014 P	9006	Golden Eiche	Dunkel Eiche	Mahogany	Rustikal Eiche	Weisse Eiche	Anthracite	PGold	PLight	PDark	PMaha	
500	●+	●*	○	○	○	●	●*	○*	○*	●*	○	○+	●	●	○	○	○*	○*	○	○	○	○	○
610	●+	●*	○			●	●*		○*		○	○+	●	●	○	○			○	○	○	○	○

● = Standard    ○ = Option (mind. 100 m<sup>2</sup>)    \* = Nur in glatt    + = Außer in glatt

# EPCO

YOUR NEEDS. OUR PANELS.

Fingerschutzpaneel mit 8mm microliniierter Außenseite.  
 Erhältlich in den Höhen 500, 555 und 610 mm.  
 Innenseite liniert, stucco-geprägt, RAL 9010.

# PANEELE RM8

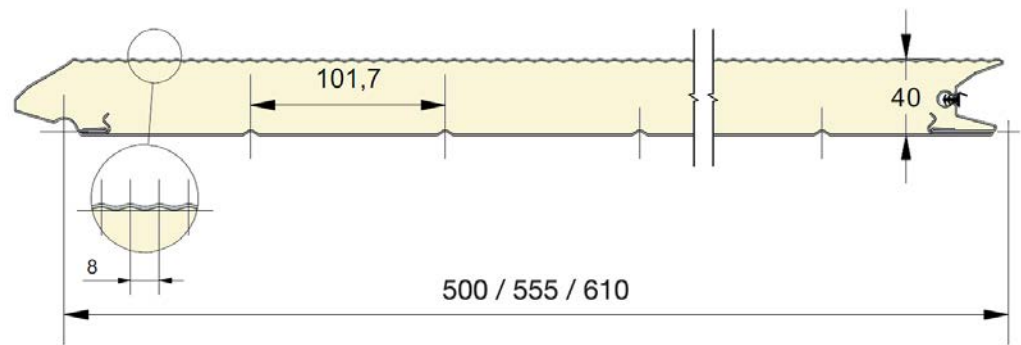

ARTIKELNR.	HÖHE	PRÄGUNG
013	500	Glatt
076	555	Glatt
014	610	Glatt

## PRÄGUNG



Glatt

## COLORS

	9016 P	1015	6005	6009 P	7016 P	7016 M	7024 M	7035 P	7039 M	8014 P	9006	Anthracite	INOX
500	●	○	○	○	●	●*	○*	○	●*	○	○	○	○
555	●				●	○*	○*		○*				
610	●	○			●	●*		○		○	○		

● = Standard    ○ = Option (mind. 100 m<sup>2</sup>)    \* = Nur in glatt

**EPCO**

YOUR NEEDS. OUR PANELS.

Fingerschutzpaneel mit 16mm microliniierter Außenseite.  
 Erhältlich in den Höhen 500, 555 und 610 mm.  
 Innenseite liniert, stucco-geprägt, RAL 9010.

# PANEEL RM16

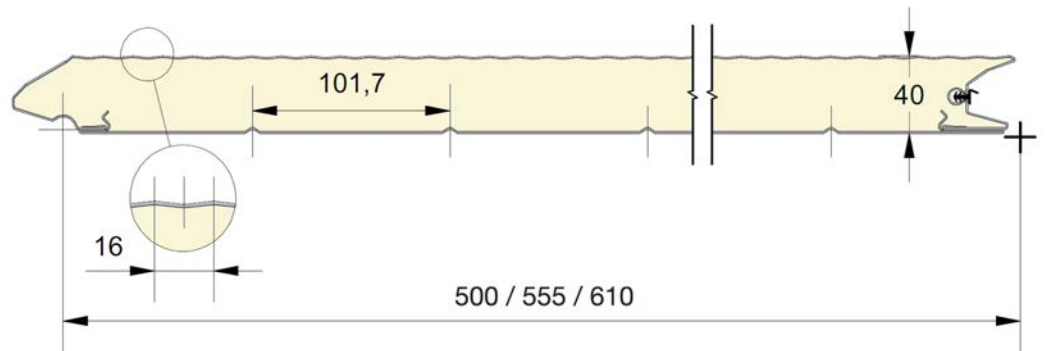

ARTIKELNR.	HÖHE	PRÄGUNG
019	500	Glatt
077	555	Glatt
020	610	Glatt

## PRÄGUNG



Glatt

## COLORS

	9016 P	1015	6005	6009 P	7016 P	7016 M	7024 M	7035 P	7039 M	8014 P	9006	Anthracite	INOX
500	●	○	○	○	●	●*	○*	○	●*	○	○	○	○
555	●				●	○*	○*		○*				
610	●	○			●	●*		○		○	○		

● = Standard    ○ = Option (mind. 100 m<sup>2</sup>)    \* = Nur in glatt

**EPCO**

YOUR NEEDS. OUR PANELS.

Fingerschutzpaneel, Außenseite mit einer Linie.  
 Erhältlich in den Höhen 500, 555 und 610 mm, Linie zentriert, up oder down  
 Innenseite liniert, stucco-geprägt, RAL 9010.

# PANEEL RV

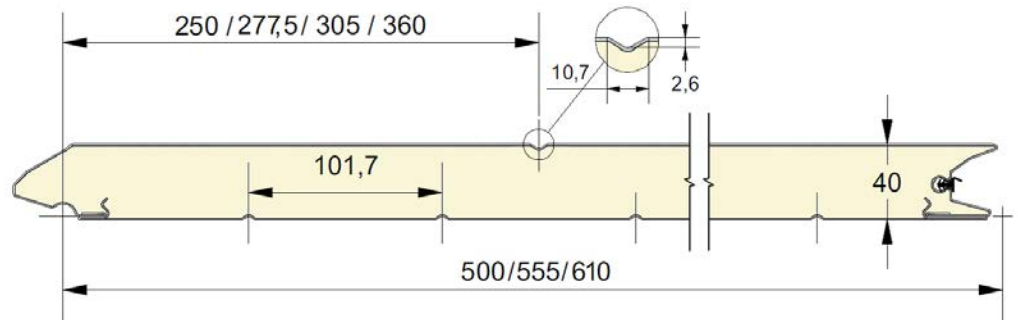

ARTIKELNR.	HÖHE	PRÄGUNG
025	500	Glatt
078	555	Glatt
026	610 CN	Glatt
027	610 UP	Glatt
028	610 DN	Glatt
029	500	Holz
079	555	Holz
030	610 CN	Holz
031	610 UP	Holz
032	610 DN	Holz
033	500	Stucco
080	555	Stucco
034	610 CN	Stucco
035	610 UP	Stucco
036	610 DN	Stucco

## PRÄGUNG

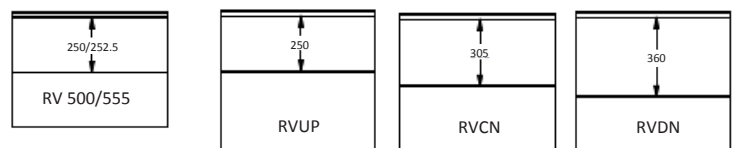

## COLORS

	9010	9016 P	1015	6005	6009 P	7016 P	7016 M	7024 M	7035 P	7039 M	8014 P	9006	Golden Eiche	Dunkel Eiche	Mahogany	Rustikal Eiche	Weisse Eiche	Anthracite	PGold	PLight	PDark	PWaha	
500	●+	●*	○	○	○	●	●*	○*	○	●*	○	○+	●	●	○	○	○*	○*	○	○	○	○	○
555	●+	●*				●	○*	○*		○*			●	○					○	○	○	○	○
610	●+	●*	○			●	●*		○		○	○+	●	●	○	○			○	○	○	○	○

● = Standard    ○ = Option (mind. 100 m<sup>2</sup>)    \* = Nur in glatt    + = Außer in glatt

# EPCO

YOUR NEEDS. OUR PANELS.



Fingerschutzpaneel, Außenseite mit einer Linie.  
Erhältlich in den Höhen 500, 555 und 610 mm.  
Innenseite liniert, stucco-geprägt, RAL 9010.

# PANEEL RT

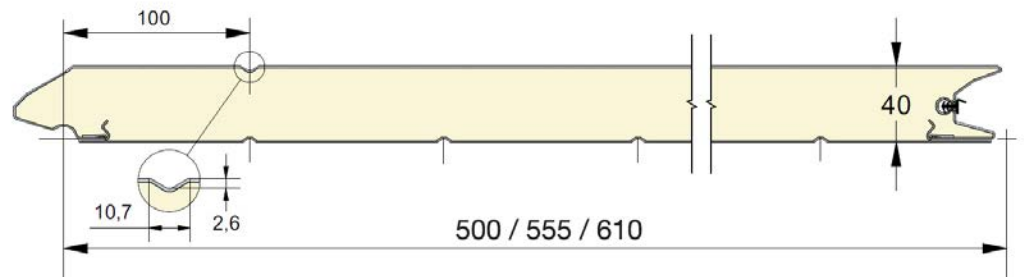

ARTIKELNR.	HÖHE	PRÄGUNG
087	500	Glatt
088	555	Glatt
089	610	Glatt
090	500	Holz
091	555	Holz
092	610	Holz
093	500	Stucco
094	555	Stucco
095	610	Stucco

## PRÄGUNG



## COLORS

	9010	9016 P	1015	6005	6009 P	7016 P	7016 M	7024 M	7035 P	7039 M	8014 P	9006	Goldene Eiche	Dunkel Eiche	Mahogany	Rustikal Eiche	Weisse Eiche	Anthracite	PGold	PLight	PDark	PMaha
500	●+	●*	○	○	○	●	●*	○*	○	●*	○	○+	●	●	○	○	○*	○*	○	○	○	○
555	●+	●*				●	○*	○*		○*			●	○					○	○	○	○
610	●+	●*	○			●	●*		○		○	○+	●	●	○	○			○	○	○	○

● = Standard    ○ = Option (mind. 100 m<sup>2</sup>)    \* = Nur in glatt    + = Außer in glatt

**EPCO**

YOUR NEEDS. OUR PANELS.

Fingerschutzpaneel, Außenseite mit Kassettenfüllung.  
 Erhältlich in den Höhen 500, 555 und 610 mm, Kassette zentriert, up oder down  
 Innenseite liniert, stucco-geprägt, RAL 9010.

# PANEEL RC

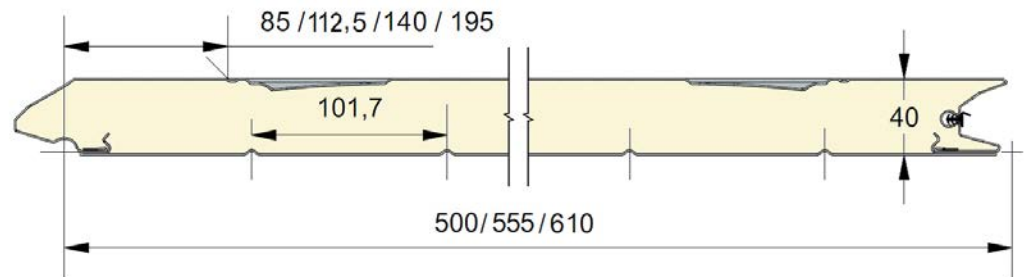

ARTIKELNR.	HÖHE	PRÄGUNG
037	500	Glatt
081	555	Glatt
038	610 CN	Glatt
039	610 UP	Glatt
040	610 DN	Glatt
041	500	Holz
082	555	Holz
042	610 CN	Holz
043	610 UP	Holz
044	610 DN	Holz

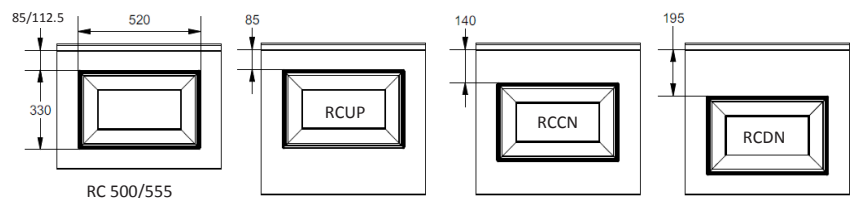

## COLORS

	9010	9016 P	8014 P	Golden Eiche	Dunkel Eiche	Mahogany	Rustikal Eiche	Weisse Eiche	PGold	PLight	PDark	PMaha
500 HOLZ	●		○	○	○	○	○		○	○	○	○
555 HOLZ	●			○	○				○	○	○	○
610 HOLZ	●		○	○	○	○	○		○	○	○	○
500 GLATT		●		●	●		○	○	○	○	○	○
555 GLATT		●		●	○				○	○	○	○
610 GLATT		●		●	●	○	○		○	○	○	○

● = Standard    ○ = Option (mind. 100 m<sup>2</sup>)

## PRÄGUNG



# EPCO

YOUR NEEDS. OUR PANELS.

Fingerschutzpaneel, Außenseite mit breiter Kassettenfüllung.  
 Erhältlich in den Höhen 500 und 610 mm, Kassette zentriert, up oder down  
 Innenseite liniert, stucco-geprägt, RAL 9010.

# PANEEEL RBC

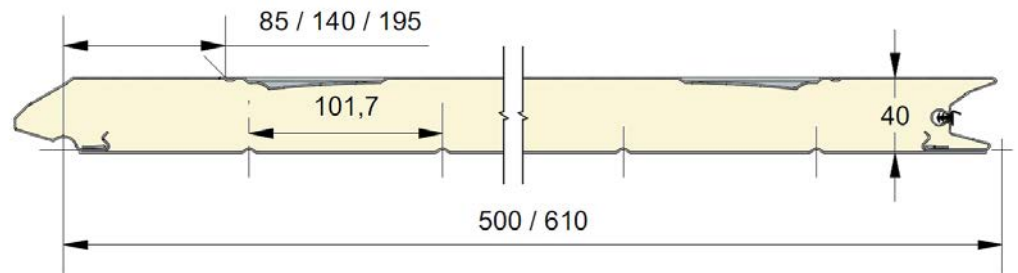

ARTIKELNR.	HÖHE	PRÄGUNG
049	500	Glatt
050	610 CN	Glatt
051	610 UP	Glatt
052	610 DN	Glatt
053	500	Holz
054	610 CN	Holz
055	610 UP	Holz
056	610 DN	Holz

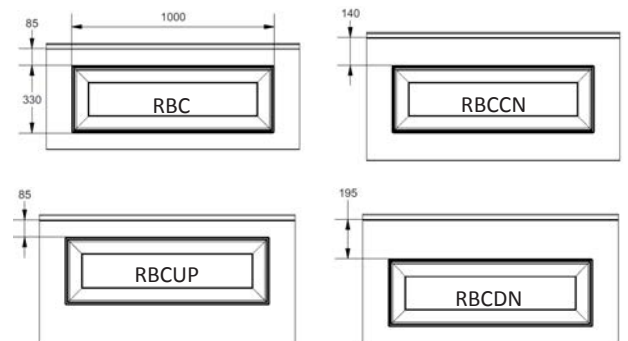

## COLORS

	9010	9016 P	8014 P	Goldene Eiche	Dunkel Eiche	Manogany	Rustikal Eiche
500 HOLZ	●		○	○	○	○	○
610 HOLZ	●		○	○	○	○	○
500 GLATT		●		●	●	○	○
610 GLATT		●		●	●	○	○

● = Standard ○ = Option (mind. 100 m<sup>2</sup>)

## PRÄGUNG



# EPCO

YOUR NEEDS. OUR PANELS.

Fingerschutzpaneel, Außenseite mit V-Längslinien.  
 Erhältlich in den Höhen 500 und 610 mm.  
 Innenseite liniert, stucco-geprägt, RAL 9010.

# PANEEL RVV

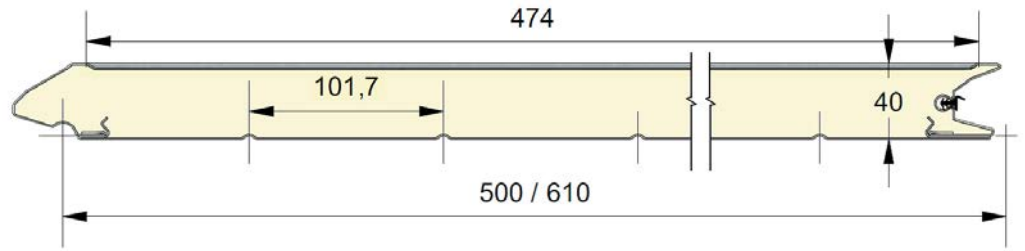

ARTIKELNR.	HÖHE	PRÄGUNG
067	500	Glatt
068	610	Glatt

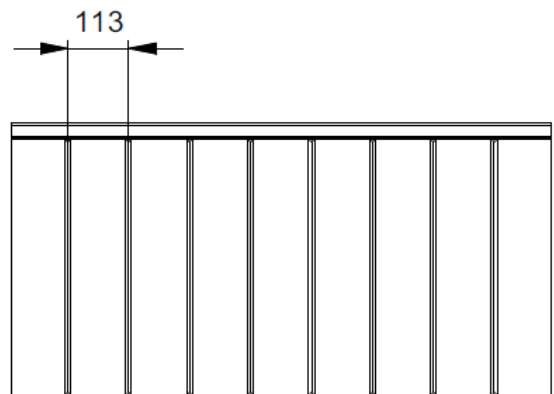

## COLORS

	9016 P
500	●
610	●

● = Standard    ○ = Option (mind. 100 m<sup>2</sup>)

## PRÄGUNG



**EPCO**

YOUR NEEDS. OUR PANELS.

Fingerschutzpaneel mit ebener Außenseite.  
Erhältlich in den Höhen 500, 555 und 610 mm.  
Innenseite liniert, stucco-geprägt, RAL 9010.

# PANEEL UF

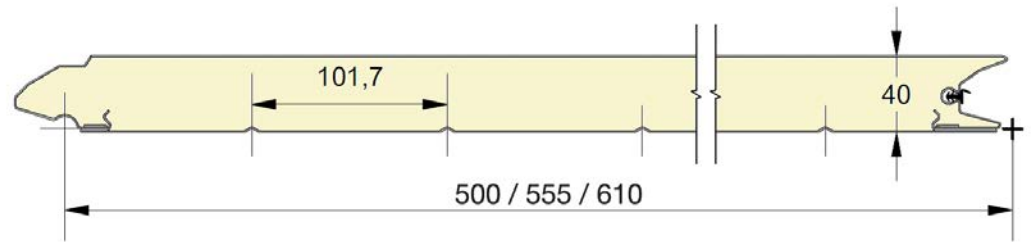

ARTIKELNR.	HÖHE	PRÄGUNG
701	500	Glatt
758	555	Glatt
702	610	Glatt
703	500	Holz
759	555	Holz
704	610	Holz
705	500	Stucco
760	555	Stucco
706	610	Stucco

## PRÄGUNG



## COLORS

	9010	9016 P	1015	6005	6009 P	7016 P	7016 M	7024 M	7035 P	7039 M	8014 P	9006	Golden Eiche	Dunkel Eiche	Mahogany	Rustikal Eiche	Weisse Eiche	Anthracite	PGold	PLight	PDark	PMaha	
500	●+	●*	○	○	○	●	●*	○*	○	●*	○	○+	●	●	○	○	○*	○*	○	○	○	○	○
555	●+	●*				●	○*	○*		○*			●	○					○	○	○	○	○
610	●+	●*	○			●	●*		○		○	○+	●	●	○	○			○	○	○	○	○

● = Standard    ○ = Option (mind. 100 m<sup>2</sup>)    \* = Nur in glatt    + = Außer in glatt

# EPCO

YOUR NEEDS. OUR PANELS.

Fingerschutzpaneel, gerillte Außenseite.  
Erhältlich in den Höhen 500, 555 und 610 mm.  
Innenseite liniert, stucco-geprägt, RAL 9010.

# PANEEL UU

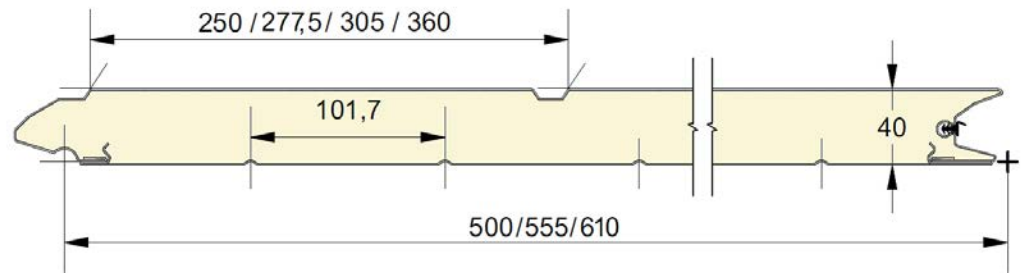

ARTIKELNR.	HÖHE	PRÄGUNG
707	500	Glatt
761	555	Glatt
708	610 CN	Glatt
709	610 UP	Glatt
710	610 DN	Glatt
711	500	Holz
762	555	Holz
712	610 CN	Holz
713	610 UP	Holz
714	610 DN	Holz
715	500	Stucco
763	555	Stucco
716	610 CN	Stucco
717	610 UP	Stucco
718	610 DN	Stucco

## PRÄGUNG



## COLORS

	9010	9016 P	1015	6005	6009 P	7016 P	7016 M	7024 M	7035 P	7039 M	8014 P	9006	Golden Eiche	Dunkel Eiche	Mahogany	Rustikal Eiche	Weisse Eiche	Anthracite	PGold	PLight	PDark	PMaha	
500	●+	●*	○	○	○	●	●*	○*	○	●*	○	○+	●	●	○	○	○*	○*	○	○	○	○	○
555	●+	●*				●	○*	○*		○*			●	○					○	○	○	○	○
610	●+	●*	○			●	●*		○		○	○+	●	●	○	○			○	○	○	○	○

● = Standard    ○ = Option (mind. 100 m<sup>2</sup>)    \* = Nur in glatt    + = Außer in glatt

**EPCO**

YOUR NEEDS. OUR PANELS.



Fingerschutzpaneel mit 8mm microliniierter Außenseite.  
 Erhältlich in den Höhen 500, 555 und 610 mm.  
 Innenseite liniert, stucco-geprägt, RAL 9010.

# PANEEL UM8

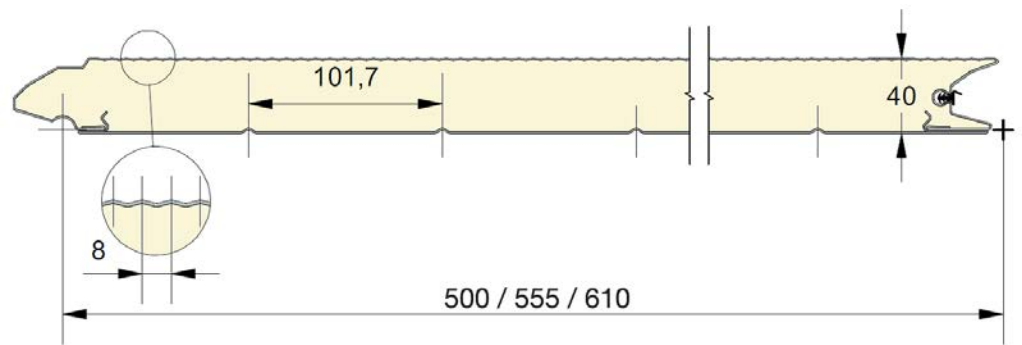

ARTIKELNR.	HÖHE	PRÄGUNG
719	500	Glatt
764	555	Glatt
720	610	Glatt

## PRÄGUNG



Glatt

## COLORS

	9016 P	1015	6005	6009 P	7016 P	7016 M	7024 M	7035 P	7039 M	8014 P	9006	Anthracite	INOX
500	●	○	○	○	●	●*	○*	○	●*	○	○	○	○
555	●				●	○*	○*		○*				
610	●	○			●	●*		○		○	○		

● = Standard    ○ = Option (mind. 100 m<sup>2</sup>)    \* = Nur in glatt

**EPCO**

YOUR NEEDS. OUR PANELS.

Fingerschutzpaneel mit 16mm V-profilierter Außenseite.  
 Erhältlich in den Höhen 500, 555 und 610 mm.  
 Innenseite liniert, stucco-geprägt, RAL 9010.

# PANEEL UM16

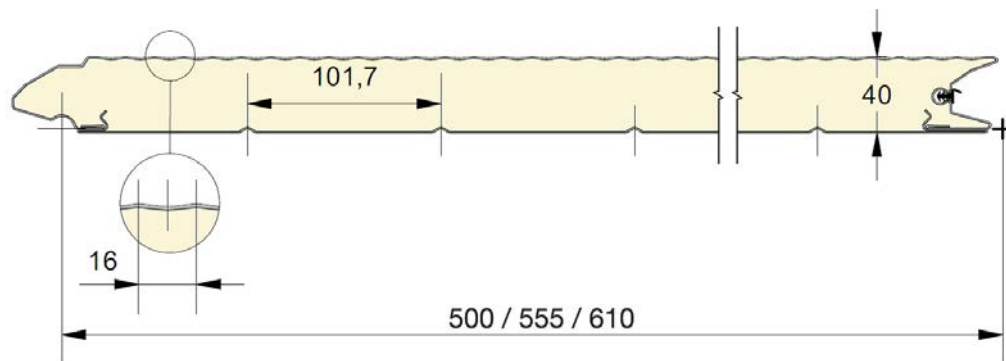

ARTIKELNR.	HÖHE	PRÄGUNG
749	500	Glatt
765	555	Glatt
750	610	Glatt

## PRÄGUNG



Glatt

## COLORS

	9016 P	1015	6005	6009 P	7016 P	7016 M	7024 M	7035 P	7039 M	8014 P	9006	Anthracite	INOX
500	●	○	○	○	●	●*	○*	○	●*	○	○	○	○
555	●				●	○*	○*		○*				
610	●	○			●	●*		○		○	○		

● = Standard    ○ = Option (mind. 100 m<sup>2</sup>)    \* = Nur in glatt

**EPCO**

YOUR NEEDS. OUR PANELS.

Fingerschutzpaneel, gerillte und 8mm microlinierte Außenseite.  
 Erhältlich in den Höhen 500 und 610 mm.  
 Innenseite liniert, stucco-geprägt, RAL 9010.

# PANEEL UUM8

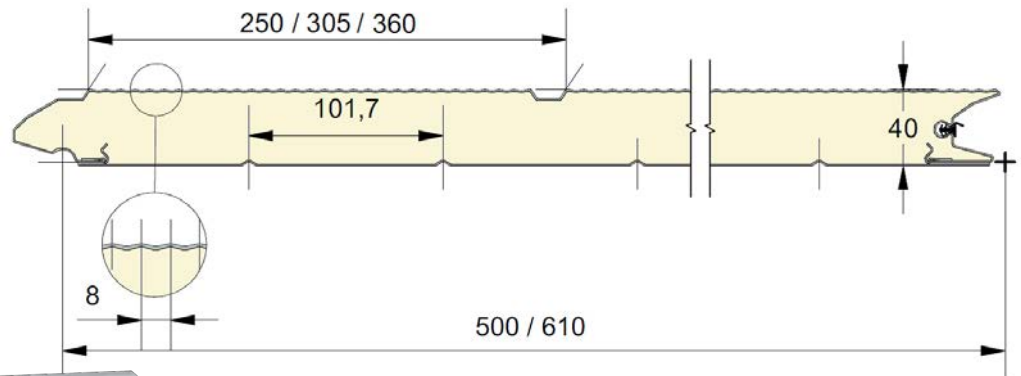

ARTIKELNR.	HÖHE	PRÄGUNG
721	500	Glatt
722	610 CN	Glatt
723	610 UP	Glatt
724	610 DN	Glatt

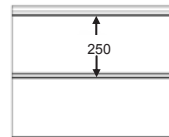

UUM8

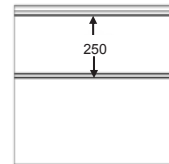

UUM8UP

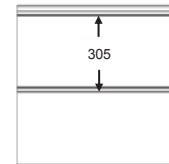

UUM8CN

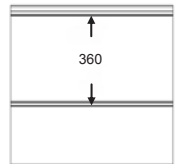

UUM8DN

## PRÄGUNG



Glatt

## COLORS

	9016 P	1015	6005	6009 P	7016 P	7016 M	7024 M	7035 P	7039 M	8014 P	9006	Anthracite	INOX
500	●	○	○	○	●	●*	○*	○	●*	○	○	○	○
610	●	○			●	●*		○		○	○		

● = Standard

○ = Option (mind. 100 m<sup>2</sup>)

\* = Nur in glatt

**EPCO**

YOUR NEEDS. OUR PANELS.

Fingerschutzpaneel, gerillte und 16mm microlinierte Außenseite.  
 Erhältlich in den Höhen 500 und 610 mm.  
 Innenseite liniert, stucco-geprägt, RAL 9010.

# PANEEL UUM16

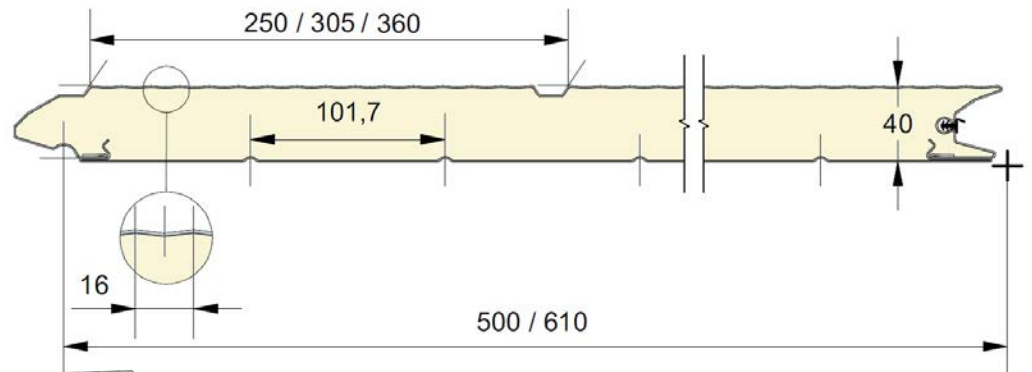

ARTIKELNR.	HÖHE	PRÄGUNG
751	500	Glatt
752	610 CN	Glatt
753	610 UP	Glatt
754	610 DN	Glatt



UUM16

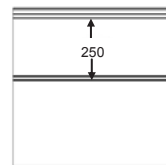

UUM16UP

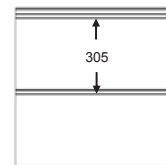

UUM16CN

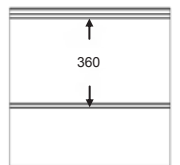

UUM16DN

## PRÄGUNG



Glatt

## COLORS

	9016 P	1015	6005	6009 P	7016 P	7016 M	7024 M	7035 P	7039 M	8014 P	9006	Anthracite	INOX
500	●	○	○	○	●	●*	○*	○	●*	○	○	○	○
610	●	○			●	●*		○		○	○		

● = Standard

○ = Option (mind. 100 m<sup>2</sup>)

\* = Nur in glatt

**EPCO**

YOUR NEEDS. OUR PANELS.

Fingerschutzpaneel mit ubere Rille.  
 Erhältlich in den Höhen 500, 555 und 610 mm.  
 Innenseite liniert, stucco-geprägt, RAL 9010.

# PANEEEL UT

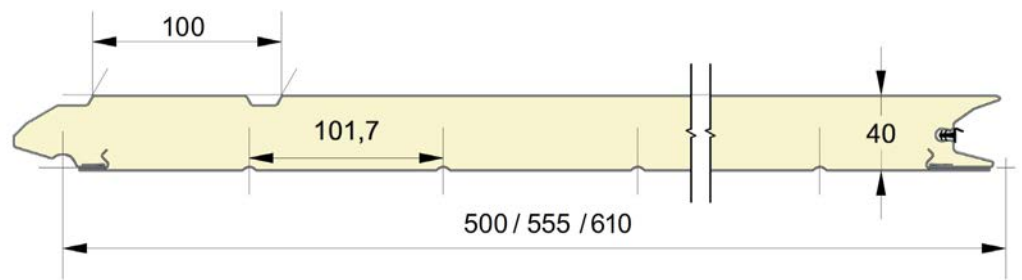

ARTIKELNR.	HÖHE	PRÄGUNG
781	500	Glatt
782	555	Glatt
783	610	Glatt
784	500	Holz
785	555	Holz
786	610	Holz
787	500	Stucco
788	555	Stucco
789	610	Stucco

## PRÄGUNG



## COLORS

	9010	9016 P	1015	6005	6009 P	7016 P	7016 M	7024 M	7035 P	7039 M	8014 P	9006	Golden Eiche	Dunkel Eiche	Mahogany	Rustikal Eiche	Weisse Eiche	Anthracite	PGold	PLight	PDark	PMaha	
500	●+	●*	○	○	○	○	○*	○*	○	○*	○	○+	○	○	○	○	○*	○*	○	○	○	○	○
555	●+	●*					○*	○*		○*				○					○	○	○	○	○
610	●+	●*	○			○	○*		○		○	○+	○	○	○	○			○	○	○	○	○

● = Standard    ○ = Option (mind. 100 m<sup>2</sup>)    \* = Nur in glatt    + = Außer in glatt

# EPCO

YOUR NEEDS. OUR PANELS.

Fingerschutzpaneel, Außenseite mit mehrere Rillen.  
 Erhältlich in den Höhen 500 und 625 mm.  
 Innenseite liniert, stucco-geprägt, RAL 9010.

# PANEEL UW

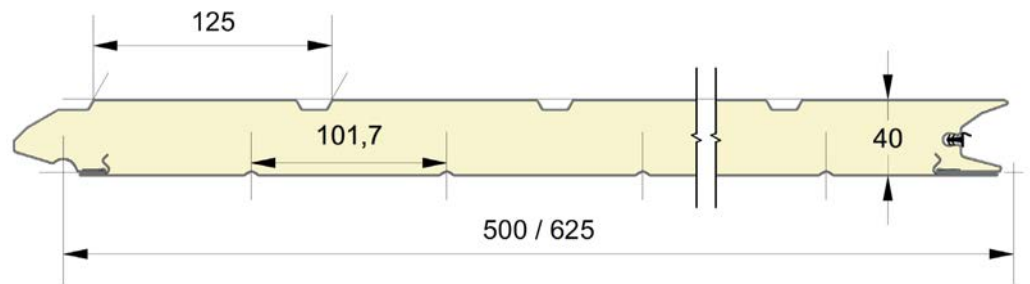

ARTIKELNR.	HÖHE	PRÄGUNG
756	500	Holz
757	500	Stucco
776	625	Holz
777	625	Stucco

## COLORS

	9010
500	○
625	○

● = Standard    ○ = Option (mind. 100 m<sup>2</sup>)

## PRÄGUNG

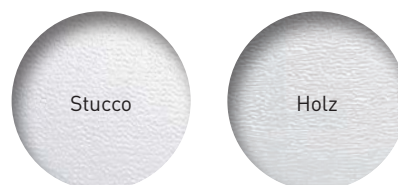

# EPCO

YOUR NEEDS. OUR PANELS.



Fingerschutzpaneel mit ebener Außenseite.  
Erhältlich in den Höhen 500 und 610 mm.  
Innenseite liniert, stucco-geprägt, RAL 9010.

# PANEEL FF

**reco**  
SERIES

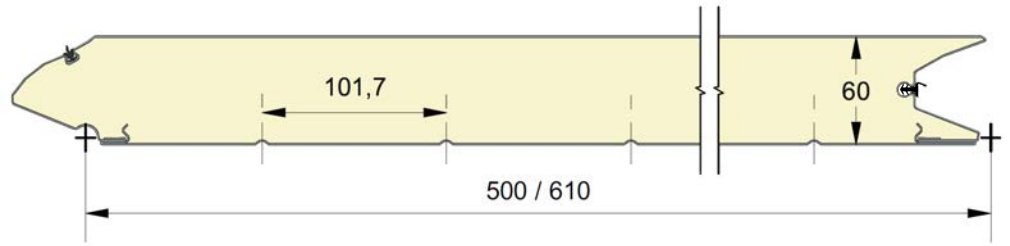

ARTIKELNR.	HÖHE	PRÄGUNG
801	500	Glatt
802	610	Glatt
803	500	Holz
804	610	Holz
805	500	Stucco
806	610	Stucco

## FARBE

	9010	9016 P	Goldene Eiche	7016 P
500	○+	●*	○	○
610	○+	●*		

## PRÄGUNG



● = Standard    ○ = Option (mind. 100 m<sup>2</sup>)    \* = Nur in glatt    + = Außer in glatt

**EPCO**

YOUR NEEDS. OUR PANELS.

Fingerschutzpaneel mit liniertes Außenseite.  
 Erhältlich in den Höhen 500 und 610mm.  
 Innenseite liniert, stucco-geprägt, RAL 9010.

# PANEEL FL

**reco**  
 SERIES

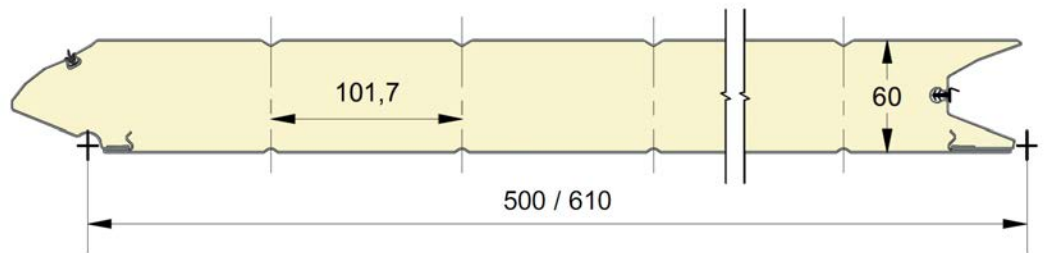

ARTIKELNR.	HÖHE	PRÄGUNG
807	500	Glatt
808	610	Glatt
809	500	Holz
810	610	Holz
811	500	Stucco
812	610	Stucco

## FARBE

	9010	9016 P	Goldene Eiche	7016 P
500	○+	●*	○	○
610	○+	●*		

## PRÄGUNG



● = Standard    ○ = Option (mind. 100 m<sup>2</sup>)    \* = Nur in glatt    + = Außer in glatt

**EPCO**

YOUR NEEDS. OUR PANELS.

Fingerschutzpaneel mit 8mm microliniierter Außenseite.  
 Erhältlich in den Höhen 500 und 610 mm.  
 Innenseite liniert, stucco-geprägt, RAL 9010.

# PANEEL **FM8**

**reco**  
 SERIES

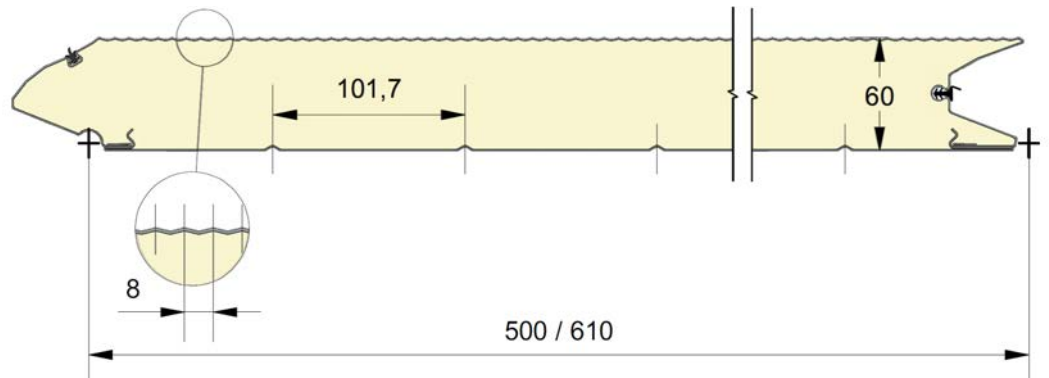

ARTIKELNR.	HÖHE	PRÄGUNG
813	500	Glatt
814	610	Glatt

## FARBE

	9016 P	7016 P
500	●	○
610	●	

● = Standard    ○ = Option (mind. 100 m<sup>2</sup>)

## PRÄGUNG



**EPCO**

YOUR NEEDS. OUR PANELS.

Fingerschutzpaneel mit 16mm microliniertes Außenseite.  
 Erhältlich in den Höhen 500 und 610 mm.  
 Innenseite liniert, stucco-geprägt, RAL 9010.

# PANEEL **FM16**

**Eco**  
SERIES

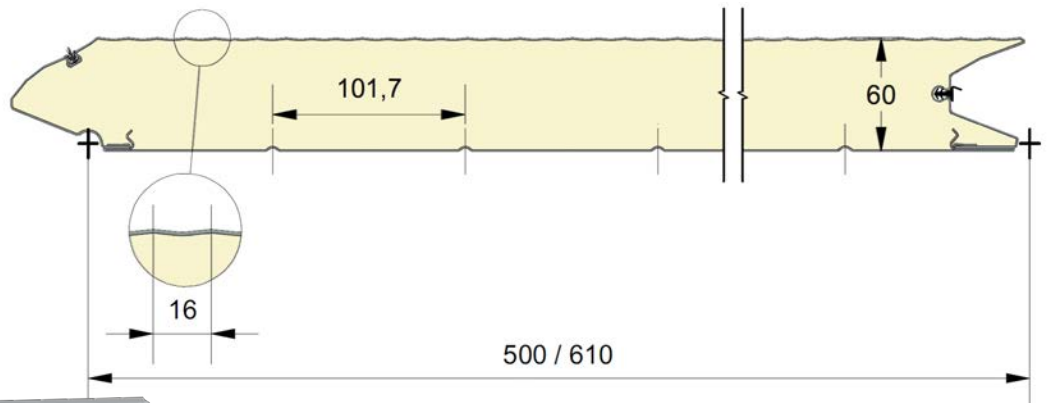

ARTIKELNR.	HÖHE	PRÄGUNG
819	500	Glatt
820	610	Glatt

## FARBE

	9016 P	7016 P
500	●	○
610	●	

● = Standard    ○ = Option (mind. 100 m<sup>2</sup>)

## PRÄGUNG



**EPCO**

YOUR NEEDS. OUR PANELS.

Fingerschutzpaneel, Außenseite mit einer Linie.  
 Erhältlich in den Höhen 500 und 610mm, Linie zentriert, up oder  
 down Innenseite liniert, stucco-geprägt, RAL 9010.

# PANEEL FV

**reco**  
SERIES

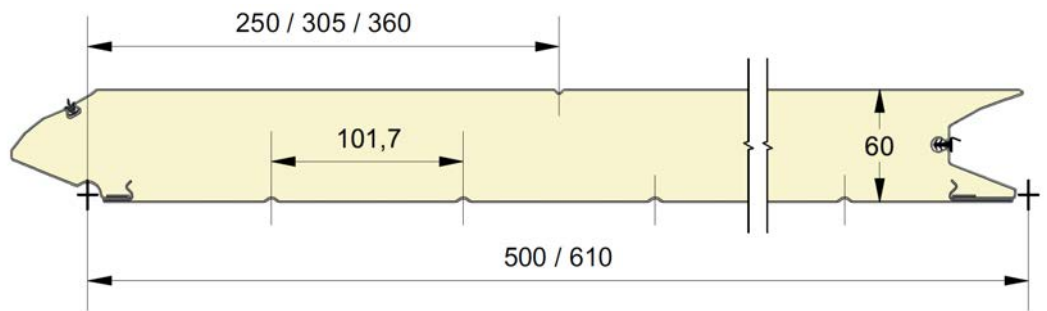

ARTIKELNR.	HÖHE	PRÄGUNG
825	500	Glatt
826	610 CN	Glatt
827	610 UP	Glatt
828	610 DN	Glatt
829	500	Holz
830	610 CN	Holz
831	610 UP	Holz
832	610 DN	Holz
833	500	Stucco
834	610 CN	Stucco
835	610 UP	Stucco
836	610 DN	Stucco



## FARBE

	9010	9016 P	Goldene Eiche	7016 P
500	○+	●*	○	○
610	○+	●*		

## PRÄGUNG



● = Standard    ○ = Option (mind. 100 m<sup>2</sup>)    \* = Nur in glatt    + = Außer in glatt

**EPCO**

YOUR NEEDS. OUR PANELS.

Fingerschutzpaneel, Außenseite mit Kassettenfüllung.  
 Erhältlich in den Höhen 500 und 610 mm, Kassette zentriert,  
 up oder down  
 Innenseite liniert, stucco-geprägt, RAL 9010.

# PANEELE FC

**reco**  
 SERIES

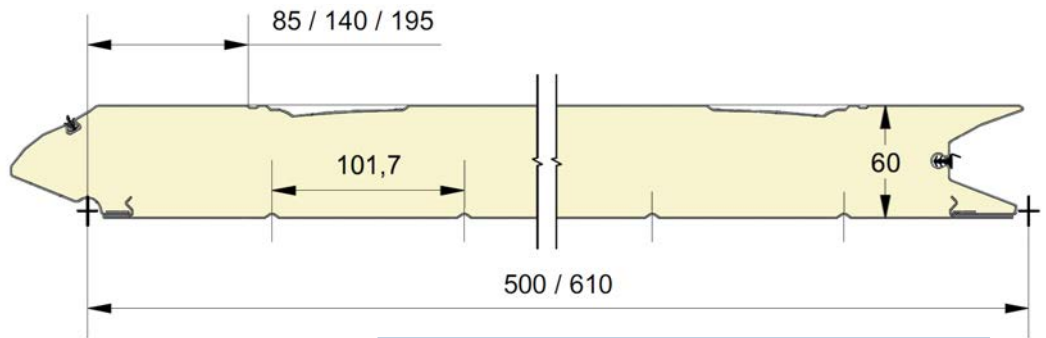

ARTIKELNR.	HÖHE	PRÄGUNG
837	500	Glatt
838	610 CN	Glatt
839	610 UP	Glatt
840	610 DN	Glatt
841	500	Holz
842	610 CN	Holz
843	610 UP	Holz
844	610 DN	Holz
845	500	Stucco
846	610 CN	Stucco
847	610 UP	Stucco
848	610 DN	Stucco

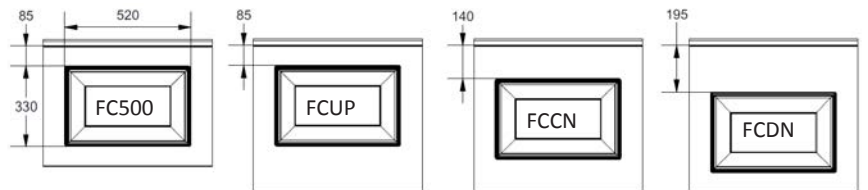

## FARBE

	9010	9016 P	Goldene Eiche
500	○+	●*	○
610	○+	●*	

## PRÄGUNG



● = Standard    ○ = Option (mind. 100 m<sup>2</sup>)    \* = Nur in glatt    + = Außer in glatt

**EPCO**

YOUR NEEDS. OUR PANELS.



Fingerschutzpaneel mit ebener Außenseite.  
Erhältlich in den Höhen 500 und 610 mm.  
Innenseite liniert, stucco-geprägt, RAL 9010.

# PANEEL GF

**reco**  
SERIES

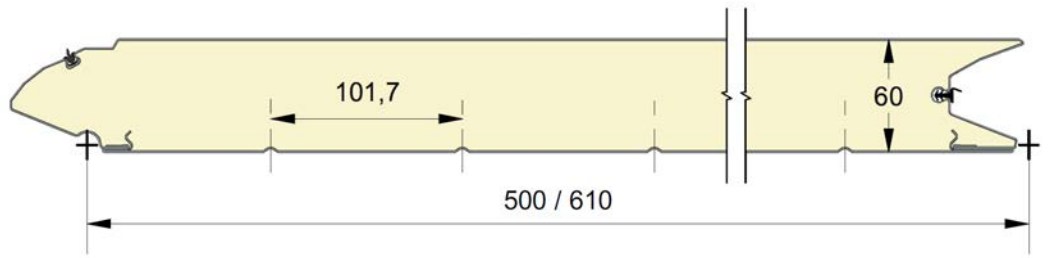

ARTIKELNR.	HÖHE	PRÄGUNG
901	500	Glatt
902	610	Glatt
903	500	Holz
904	610	Holz
905	500	Stucco
906	610	Stucco

## FARBE

	9010	9016 P	Goldene Eiche	7016 P
500	○+	●*	○	○
610	○+	●*		

## PRÄGUNG



● = Standard    ○ = Option (mind. 100 m<sup>2</sup>)    \* = Nur in glatt    + = Außer in glatt

**EPCO**

YOUR NEEDS. OUR PANELS.

Fingerschutzpaneel, gerillte Außenseite.  
Erhältlich in den Höhen 500 und 610 mm.  
Innenseite liniert, stucco-geprägt, RAL 9010.

# PANEEEL **GU**

**reco**  
SERIES

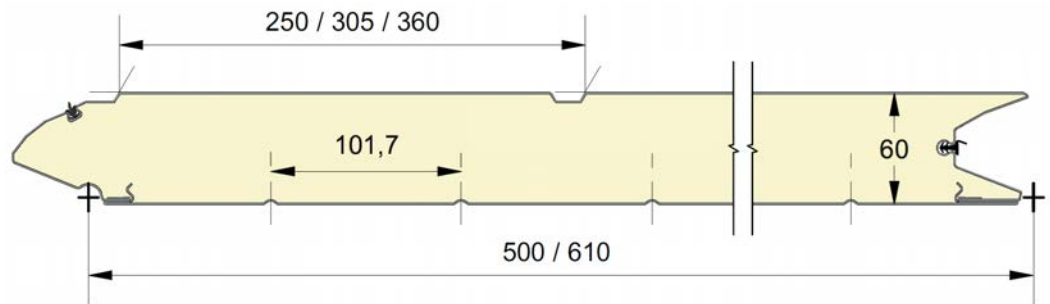

ARTIKELNR.	HÖHE	PRÄGUNG
907	500	Glatt
908	610 CN	Glatt
909	610 UP	Glatt
910	610 DN	Glatt
911	500	Holz
912	610 CN	Holz
913	610 UP	Holz
914	610 DN	Holz
915	500	Stucco
916	610 CN	Stucco
917	610 UP	Stucco
918	610 DN	Stucco

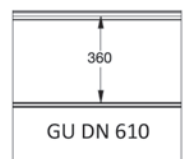
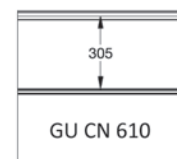
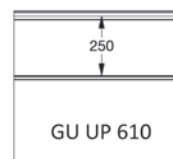
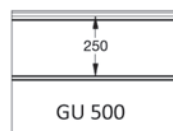

## FARBE

	9010	9016 P	Goldene Eiche	7016 P
500	○+	●*	○	○
610	○+	●*		

## PRÄGUNG



● = Standard   ○ = Option (mind. 100 m<sup>2</sup>)   \* = Nur in glatt   + = Außer in glatt

**EPCO**

YOUR NEEDS. OUR PANELS.

Fingerschutzpaneel, übergerillte Außenseite.  
 Erhältlich in den Höhen 500 und 610 mm.  
 Innenseite liniert, stucco-geprägt, RAL 9010.

# PANEEL GT

**reco**  
 SERIES

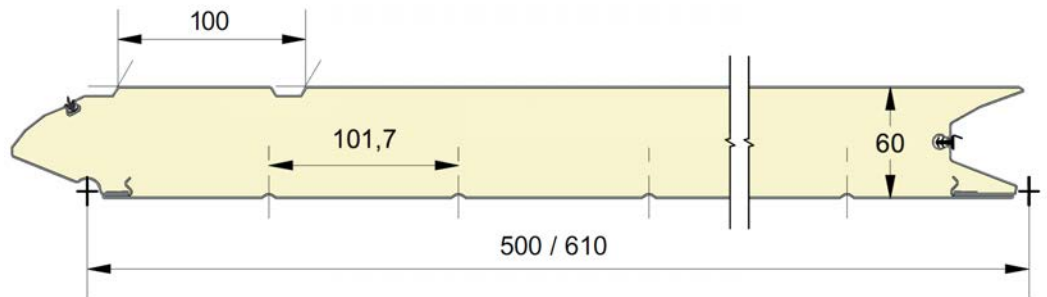

ARTIKELNR.	HÖHE	PRÄGUNG
955	500	Glatt
956	610	Glatt
957	500	Holz
958	610	Holz
959	500	Stucco
960	610	Stucco

## FARBE

	9010	9016 P	Goldene Eiche	7016 P
500	○+	●*	○	○
610	○+	●*		

## PRÄGUNG



● = Standard    ○ = Option (mind. 100 m<sup>2</sup>)    \* = Nur in glatt    + = Außer in glatt

**EPCO**

YOUR NEEDS. OUR PANELS.

Fingerschutzpaneel mit 8mm microliniierter Außenseite.  
 Erhältlich in den Höhen 500 und 610 mm.  
 Innenseite liniert, stucco-geprägt, RAL 9010.

# PANEELE GM8

**reco**  
SERIES

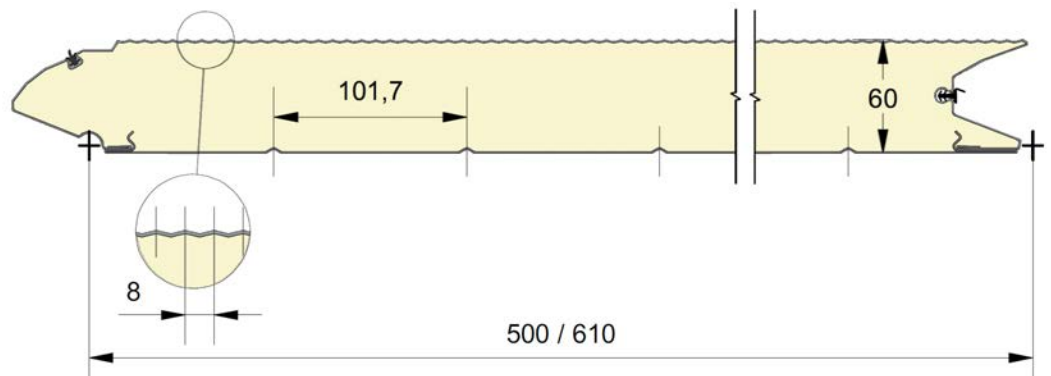

ARTIKELNR.	HÖHE	PRÄGUNG
919	500	Glatt
920	610	Glatt

## FARBE

	9016 P	7016 P
500	<input checked="" type="radio"/>	<input type="radio"/>
610	<input checked="" type="radio"/>	<input type="radio"/>

= Standard     = Option (mind. 100 m<sup>2</sup>)

## PRÄGUNG



**EPCO**

YOUR NEEDS. OUR PANELS.

Fingerschutzpaneel mit 16mm microliniertes Außenseite.  
 Erhältlich in den Höhen 500 und 610 mm.  
 Innenseite liniert, stucco-geprägt, RAL 9010.

# PANEELE GM16

**reco**  
SERIES

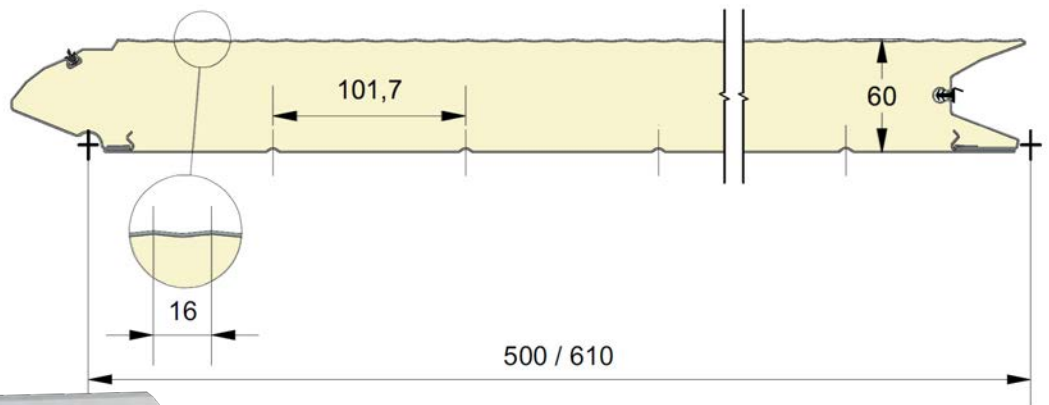

ARTIKELNR.	HÖHE	PRÄGUNG
949	500	Glatt
950	610	Glatt

## FARBE

	9016 P	7016 P
500	●	○
610	●	

● = Standard    ○ = Option (mind. 100 m<sup>2</sup>)

## PRÄGUNG



**EPCO**

YOUR NEEDS. OUR PANELS.

Fingerschutzpaneel, gerillte und 8mm microlinierte Außenseite.  
 Erhältlich in den Höhen 500 und 610 mm.  
 Innenseite liniert, stucco-geprägt, RAL 9010.

# PANEELE GUM8

**reco**  
SERIES

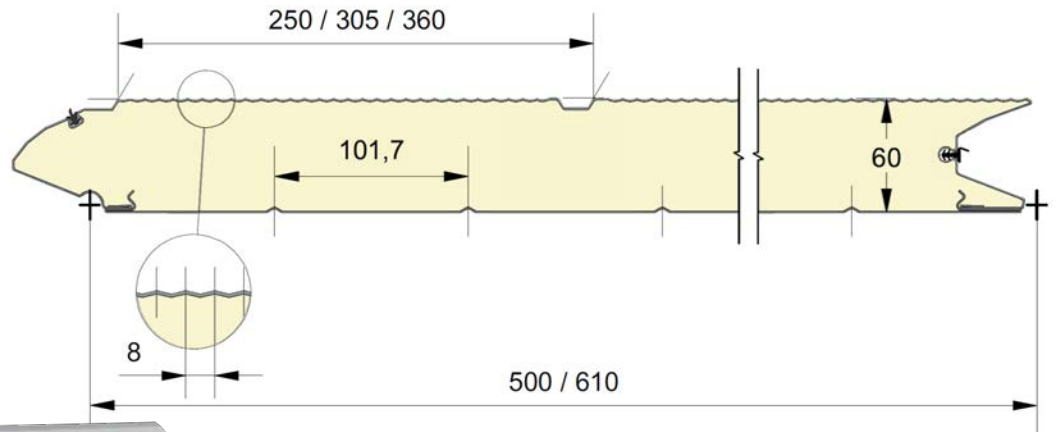

ARTIKELNR.	HÖHE	PRÄGUNG
921	500	Glatt
922	610 CN	Glatt
923	610 UP	Glatt
924	610 DN	Glatt

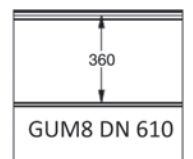
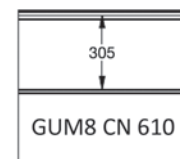
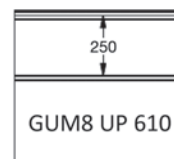

## FARBE

	9016 P	7016 P
500	●	○
610	●	

● = Standard    ○ = Option (mind. 100 m<sup>2</sup>)

## PRÄGUNG



**EPCO**

YOUR NEEDS. OUR PANELS.



Fingerschutzpaneel, gerillte und 16mm microlinierte Außenseite.  
 Erhältlich in den Höhen 500 und 610 mm.  
 Innenseite liniert, stucco-geprägt, RAL 9010.

# PANEELE GUM16

**reco**  
SERIES

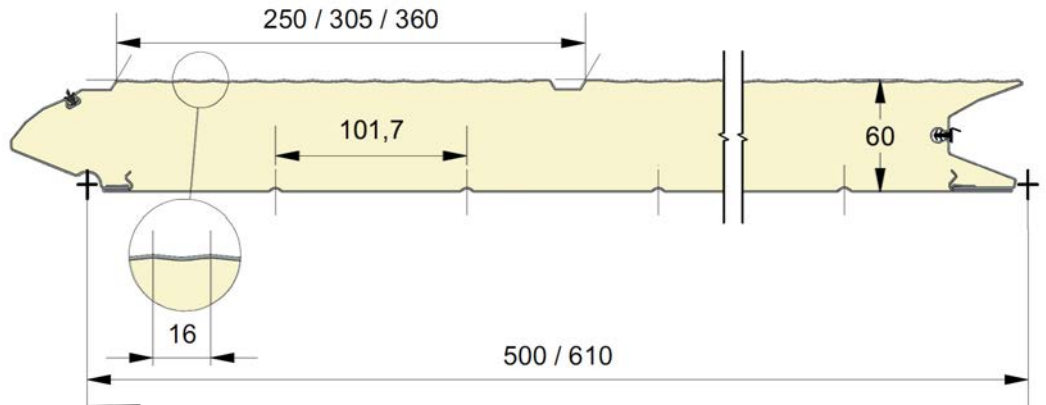

ARTIKELNR.	HÖHE	PRÄGUNG
951	500	Glatt
952	610 CN	Glatt
953	610 UP	Glatt
954	610 DN	Glatt

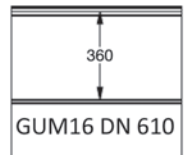
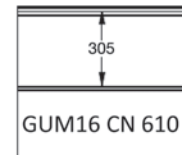
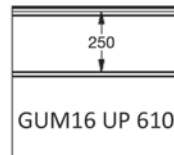
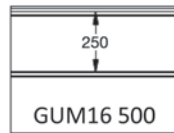

## FARBE

	9016 P	7016 P
500	●	○
610	●	

● = Standard    ○ = Option (mind. 100 m<sup>2</sup>)

## PRÄGUNG



**EPCO**

YOUR NEEDS. OUR PANELS.

Fingerschutzpaneel mit ebener Außenseite.  
Erhältlich in den Höhen 500, 553 und 610 mm.  
Innenseite liniert, stucco-geprägt, RAL 9010.

# PANEELE SF

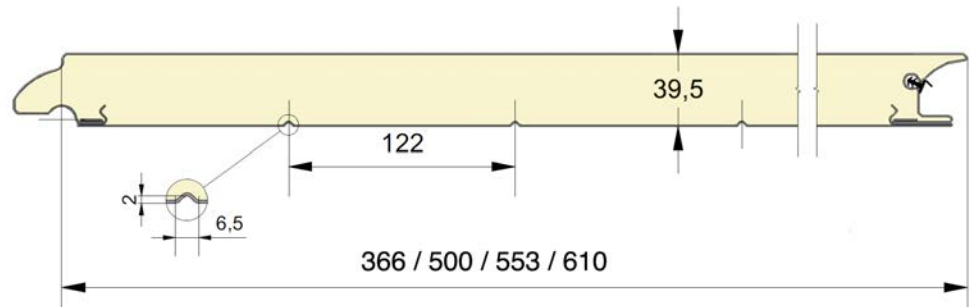

ARTIKELNR.	HÖHE	PRÄGUNG
1201	500	Glatt
1281	553	Glatt
1202	610	Glatt
1203	500	Holz
1282	553	Holz
1204	610	Holz
1270	366	Stucco
1205	500	Stucco
1283	553	Stucco
1206	610	Stucco

## Prägung



## FARBE

	9002	9010	9016 P	1015	6005	6009 P	7016 P	7016 M	7024 M	7035 P	7039 M	8014 P	9006	PGold	PLight	PDark	PMaha
366	○																
500	●+	○+	●*	○	○	○	○	○*	○*	○*	○*	○	○+	○	○	○	○
553		○+	●*				○	○*	○*		○*			○	○	○	○
610	●+	○+	●*	○			○	○*		○*		○	○+	○	○	○	○

● = Standard    ○ = Option (mind. 100 m<sup>2</sup>)    \* = Nur in glatt    + = Außer in glatt

**EPCO**

YOUR NEEDS. OUR PANELS.

Fingerschutzpaneel mit liniertes Außenseite.  
Erhältlich in den Höhen 500 und 610 mm.  
Innenseite liniert, stucco-geprägt, RAL 9010.

# PANEEEL SL

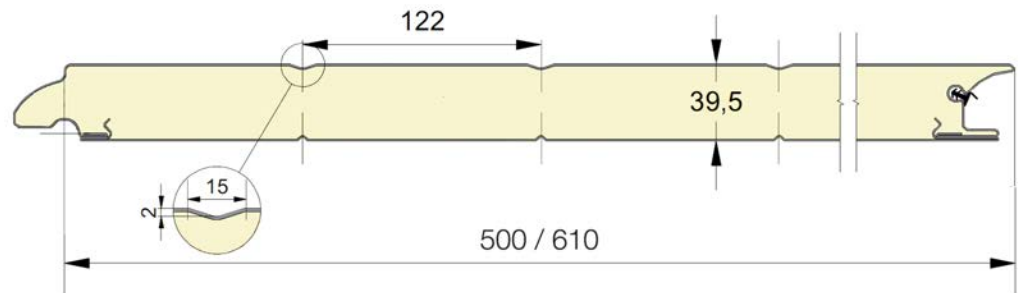

ARTIKELNR.	HÖHE	PRÄGUNG
1207	500	Glatt
1208	610	Glatt
1209	500	Holz
1210	610	Holz
1211	500	Stucco
1212	610	Stucco

## PRÄGUNG



## FARBE

	9002	9010	9016 P	1015	6005	6009 P	7016 P	7016 M	7024 M	7035 P	7039 M	8014 P	9006	PGold	PLight	PDark	PMaha
500	●+	●+	●*	○	○	○	○	○*	○*	○*	○*	○	○+	○	○	○	○
610	●+	●+	●*	○			○	○*		○*		○	○+	○	○	○	○

● = Standard    ○ = Option (mind. 100 m<sup>2</sup>)    \* = Nur in glatt    + = Außer in glatt

**EPCO**

YOUR NEEDS. OUR PANELS.

Fingerschutzpaneel, Außenseite mit einer Linie.  
Erhältlich in den Höhen 500, 533 und 610 mm  
Innenseite liniert, stucco-geprägt, RAL 9010.

# PANEEL SV

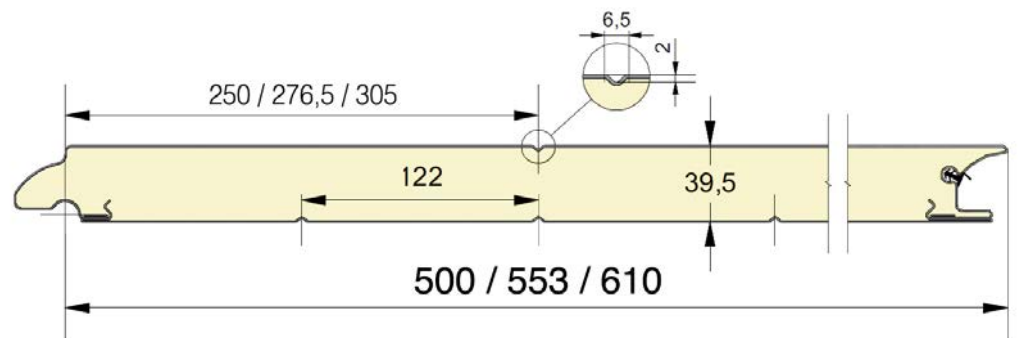

ARTIKELNR.	HÖHE	PRÄGUNG
1225	500	Glatt
1284	553	Glatt
1226	610	Glatt
1229	500	Holz
1285	553	Holz
1230	610	Holz
1233	500	Stucco
1286	553	Stucco
1233	610	Stucco

## PRÄGUNG



## FARBE

	9002	9010	9016 P	1015	6005	6009 P	7016 P	7016 M	7024 M	7035 P	7039 M	8014 P	9006	PGold	PLight	PDark	PMaha
500	●+	●+	●*	○	○	○	○	○*	○*	○*	○*	○	○+	○	○	○	○
553		●+	●*				○	○*	○*		○*			○	○	○	○
610	●+	●+	●*	○			○	○*		○*		○	○+	○	○	○	○

● = Standard    ○ = Option (mind. 100 m<sup>2</sup>)    \* = Nur in glatt    + = Außer in glatt

**EPCO**

YOUR NEEDS. OUR PANELS.

Fingerschutzpaneel mit 8mm microliniertes Außenseite.  
 Erhältlich in den Höhen 500 und 610 mm.  
 Innenseite liniert, stucco-geprägt, RAL 9010.

# PANEEL SM8

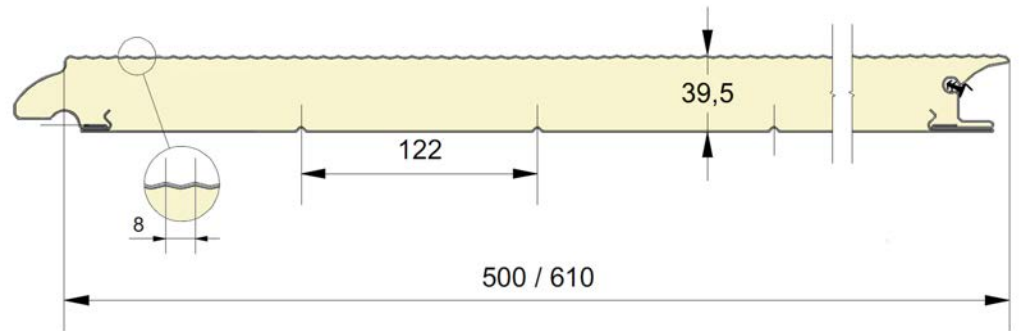

ARTIKELNR.	HÖHE	PRÄGUNG
1213	500	Glatt
1214	610	Glatt

## PRÄGUNG



## FARBE

	9002	9016 P	1015	6005	6009 P	7016 P	7016 M	7024 M	7035 P	7039 M	8014 P	9006
500	●	●	○	○	○	○	○*	○*	○*	○*	○	○
610	●	●	○			○	○*		○*		○	○

● = Standard    ○ = Option (mind. 100 m<sup>2</sup>)    \* = Nur in glatt    + = Außer in glatt

**EPCO**

YOUR NEEDS. OUR PANELS.

Fingerschutzpaneel mit 16mm microliniertes Außenseite.  
 Erhältlich in den Höhen 500 und 610 mm.  
 Innenseite liniert, stucco-geprägt, RAL 9010.

# PANEEL SM16

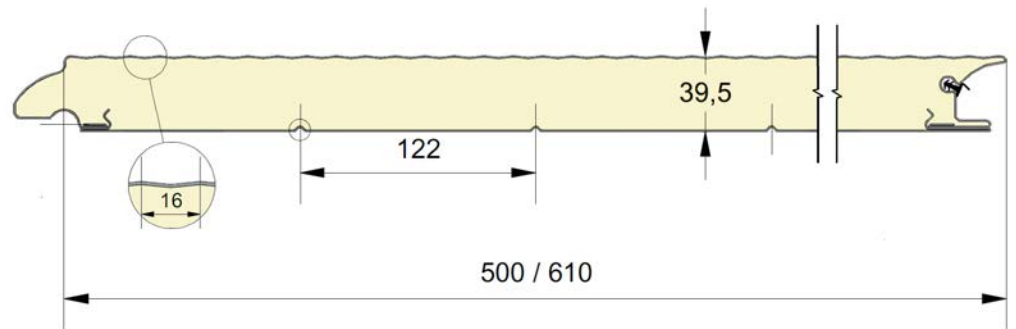

ARTIKELNR.	HÖHE	PRÄGUNG
1219	500	Glatt
1220	610	Glatt

## PRÄGUNG



Glatt

## FARBE

	9002	9016 P	1015	6005	6009 P	7016 P	7016 M	7024 M	7035 P	7039 M	8014 P	9006
500	●	●	○	○	○	○	○*	○*	○*	○*	○	○
610	●	●	○			○	○*		○*		○	○

● = Standard    ○ = Option (mind. 100 m<sup>2</sup>)    \* = Nur in glatt    + = Außer in glatt

**EPCO**

YOUR NEEDS. OUR PANELS.



Fingerschutzpaneel mit ebener Außenseite.  
Erhältlich in den Höhen 500 und 610 mm.  
Innenseite liniert, stucco-geprägt, RAL 9010.

# PANEEL KF

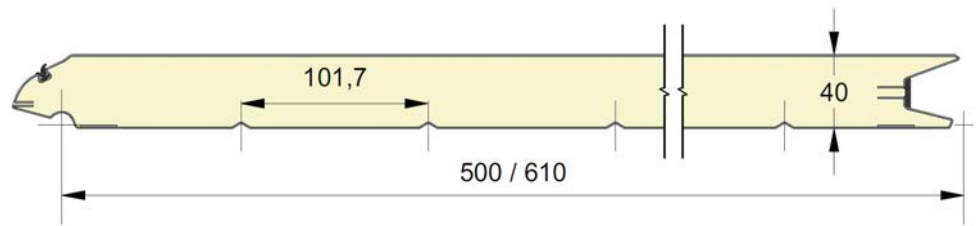

ARTIKELNR.	HÖHE	PRÄGUNG
1501	500	Glatt
1502	610	Glatt
1503	500	Holz
1504	610	Holz
1505	500	Stucco
1506	610	Stucco

## PRÄGUNG



## FARBE

	9010	9016 P	7016 P	7016 M	8014 P	9006	Golden Eiche	Dunkel Eiche	PGold	PLight	PDark	PMaha
500	○+	●*	●	○*	○	○+	○	○	○	○	○	○
610	○+	●*	●	○*	○	○+	○	○	○	○	○	○

● = Standard    ○ = Option (mind. 100 m<sup>2</sup>)    \* = Nur in glatt    + = Außer in glatt

**EPCO**

YOUR NEEDS. OUR PANELS.

Fingerschutzpaneel mit liniertes Außenseite.  
Erhältlich in den Höhen 500 und 610 mm.  
Innenseite liniert, stucco-geprägt, RAL 9010.

# PANEEL KL

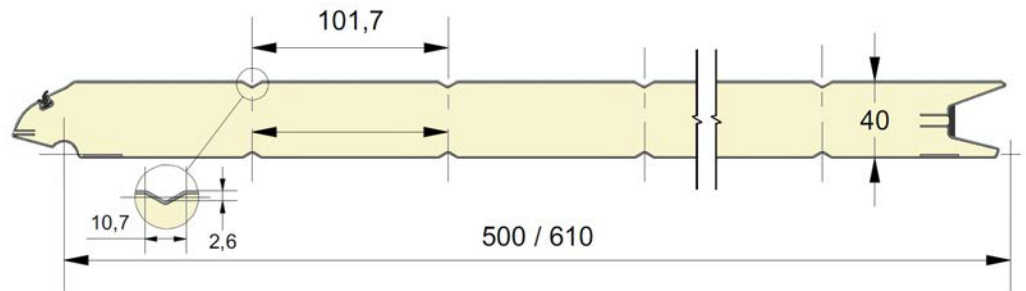

ARTIKELNR.	HÖHE	PRÄGUNG
1507	500	Glatt
1508	610	Glatt
1509	500	Holz
1510	610	Holz
1511	500	Stucco
1512	610	Stucco

## PRÄGUNG



## FARBE

	9010	9016 P	7016 P	7016 M	8014 P	9006	Golden Eiche	Dunkel Eiche	PGold	PLight	PDark	PMaha
500	○+	●*	●	○*	○	○+	○	○	○	○	○	○
610	○+	●*	●	○*	○	○+	○	○	○	○	○	○

● = Standard    ○ = Option (mind. 100 m<sup>2</sup>)    \* = Nur in glatt    + = Außer in glatt

**EPCO**

YOUR NEEDS. OUR PANELS.

Fingerschutzpaneel mit 8mm microliniierter Außenseite.  
 Erhältlich in den Höhen 500 und 610 mm.  
 Innenseite liniert, stucco-geprägt, RAL 9010.

# PANEEL KM8

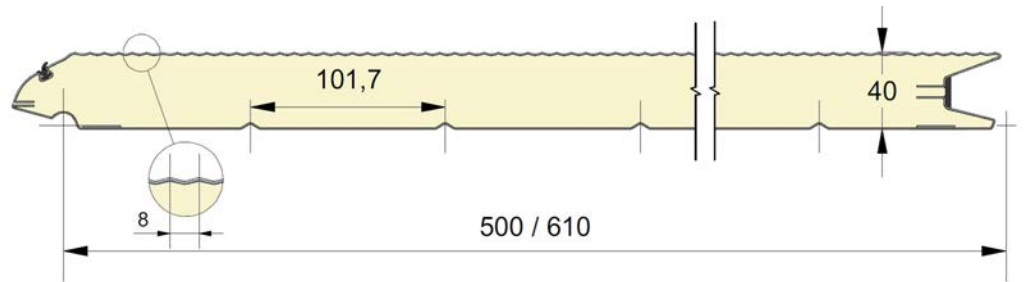

ARTIKELNR.	HÖHE	PRÄGUNG
1513	500	Glatt
1514	610	Glatt

## FARBE

	9016 P	7016 P	7016 M	9006
500	●	●	○	○
610	●	●	○	○

● = Standard    ○ = Option (mind. 100 m<sup>2</sup>)

## PRÄGUNG



# EPCO

YOUR NEEDS. OUR PANELS.

Fingerschutzpaneel mit 16mm V-profilierter Außenseite.  
 Erhältlich in den Höhen 500 und 610 mm.  
 Innenseite liniert, stucco-geprägt, RAL 9010.

# PANEEL KM16

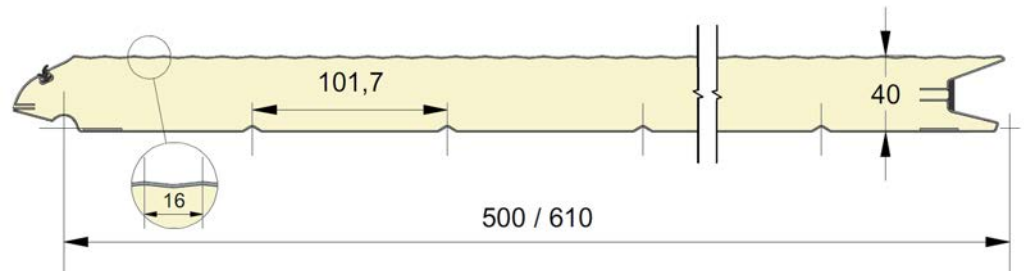

ARTIKELNR.	HÖHE	PRÄGUNG
1519	500	Glatt
1520	610	Glatt

## FARBE

	9016 P	7016 P	7016 M	9006
500	●	●	○	○
610	●	●	○	○

● = Standard    ○ = Option (mind. 100 m<sup>2</sup>)

## PRÄGUNG



# EPCO

YOUR NEEDS. OUR PANELS.

Fingerschutzpaneel, Außenseite mit einer Linie.  
 Erhältlich in den Höhen 500 und 610 mm, Linie zentriert, up oder down  
 Innenseite liniert, Stucco geprägt, RAL 9010.

# PANEEL KV

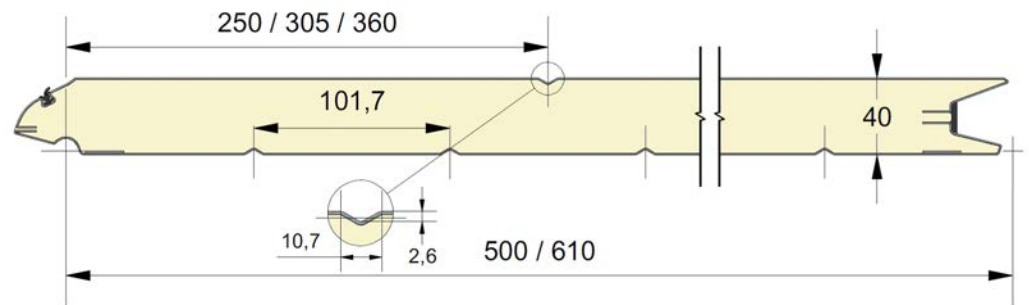

ARTIKELNR.	HÖHE	PRÄGUNG
1525	500	Glatt
1526	610 CN	Glatt
1527	610 UP	Glatt
1528	610 DN	Glatt
1529	500	Holz
1530	610 CN	Holz
1531	610 UP	Holz
1532	610 DN	Holz
1533	500	Stucco
1534	610 CN	Stucco
1535	610 UP	Stucco
1536	610 DN	Stucco

## PRÄGUNG

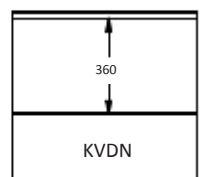
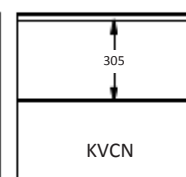
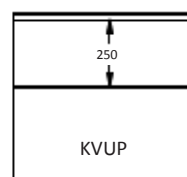
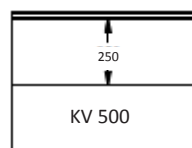

## FARBE

	9010	9016 P	7016 P	7016 M	8014 P	9006	Goldene Eiche	Dunkel Eiche	PGold	PLight	PDark	PMaha
500	○+	●*	●	○*	○	○+	○	○	○	○	○	○
610	○+	●*	●	○*	○	○+	○	○	○	○	○	○

● = Standard    ○ = Option (mind. 100 m<sup>2</sup>)    \* = Nur in glatt    + = Außer in glatt

**EPCO**

YOUR NEEDS. OUR PANELS.

Fingerschutzpaneel, Außenseite mit ubere Linie.  
 Erhältlich in den Höhen 500 und 610 mm.  
 Innenseite liniert, Stucco geprägt, RAL 9010.

# PANEEL KT

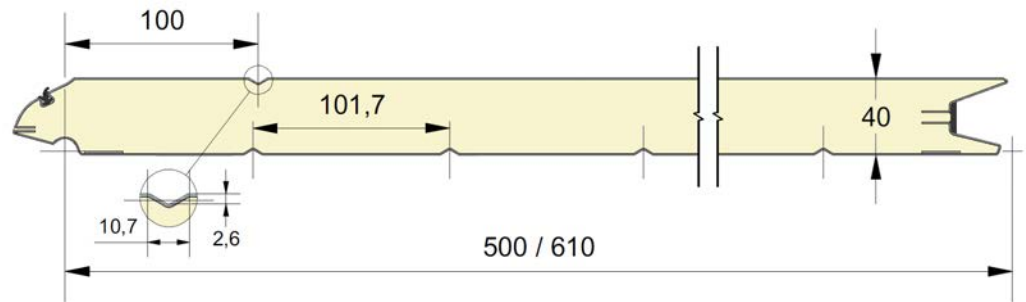

ARTIKELNR.	HÖHE	PRÄGUNG
1590	500	Glatt
1592	610	Glatt
1593	500	Holz
1595	610	Holz
1596	500	Stucco
1598	610	Stucco

## PRÄGUNG



## FARBE

	9010	9016 P	7016 P	7016 M	8014 P	9006	Golden Eiche	Dunkel Eiche	PGold	PLight	PDark	PMaha
500	○+	●*	●	○*	○	○+	○	○	○	○	○	○
610	○+	●*	●	○*	○	○+	○	○	○	○	○	○

● = Standard    ○ = Option (mind. 100 m<sup>2</sup>)    \* = Nur in glatt    + = Außer in glatt

**EPCO**

YOUR NEEDS. OUR PANELS.



Fingerschutzpaneel, Außenseite mit Kassettenfüllung.  
 Erhältlich in den Höhen 500 und 610 mm, Kassette zentriert, up oder down  
 Innenseite liniert, stucco-geprägt, RAL 9010.

# PANEEL KC

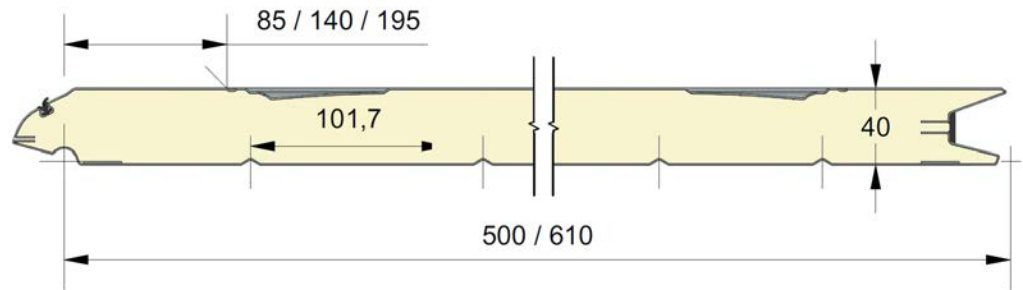

ARTIKELNR.	HÖHE	PRÄGUNG
1537	500	Glatt
1538	610 CN	Glatt
1539	610 UP	Glatt
1540	610 DN	Glatt
1541	500	Holz
1542	610 CN	Holz
1543	610 UP	Holz
1544	610 DN	Holz
1545	500	Stucco
1546	610 CN	Stucco
1547	610 UP	Stucco
1548	610 DN	Stucco

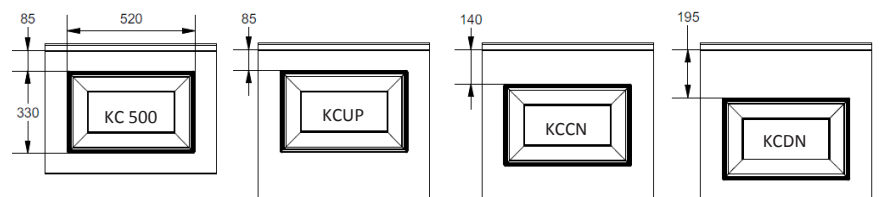

## FARBE

	9010	9016 P	8014 P	Goldene Eiche	Dunkel Eiche	PGold	PLight	PDark	PMaha
500 BOIS	●		○	○	○	○	○	○	○
610 BOIS	●		○	○	○	○	○	○	○
500 LISSE		○		○	○	○	○	○	○
610 LISSE		○		○	○	○	○	○	○

● = Standard ○ = Option (mind. 100 m<sup>2</sup>)

## PRÄGUNG



**EPCO**

YOUR NEEDS. OUR PANELS.

Fingerschutzpaneel mit ebener Außenseite.  
Erhältlich in den Höhen 500 und 610 mm.  
Innenseite liniert, stucco-geprägt, RAL 9010.

# PANEEL LF

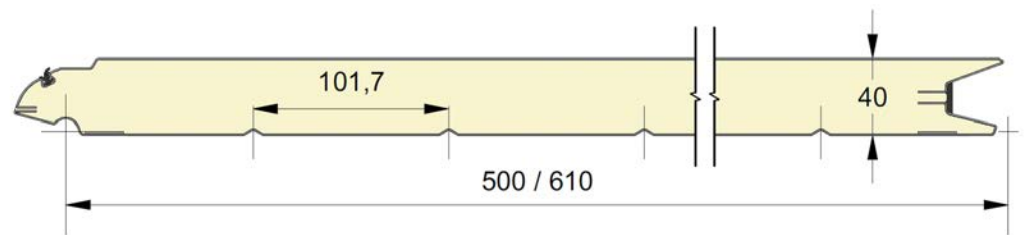

ARTIKELNR.	HÖHE	PRÄGUNG
1601	500	Glatt
1602	610	Glatt
1603	500	Holz
1604	610	Holz
1605	500	Stucco
1606	610	Stucco

## PRÄGUNG



## FARBE

	9010	9016 P	7016 P	7016 M	8014 P	9006	Golden Eiche	Dunkel Eiche	PGold	PLight	PDark	PMaha
500	○+	●*	●	○*	○	○+	○	○	○	○	○	○
610	○+	●*	●	○*	○	○+	○	○	○	○	○	○

● = Standard    ○ = Option (mind. 100 m<sup>2</sup>)    \* = Nur in glatt    + = Außer in glatt

**EPCO**

YOUR NEEDS. OUR PANELS.

Fingerschutzpaneel, gerillte Außenseite.  
Erhältlich in den Höhen 500 und 610 mm.  
Innenseite liniert, stucco-geprägt, RAL 9010.

# PANEEEL LU

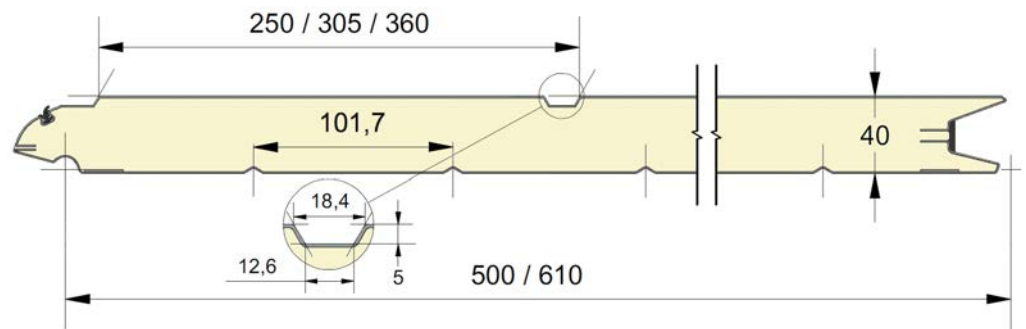

ARTIKELNR.	HÖHE	PRÄGUNG
1607	500	Glatt
1608	610 CN	Glatt
1609	610 UP	Glatt
1610	610 DN	Glatt
1611	500	Holz
1612	610 CN	Holz
1613	610 UP	Holz
1614	610 DN	Holz
1615	500	Stucco
1616	610 CN	Stucco
1617	610 UP	Stucco
1618	610 DN	Stucco

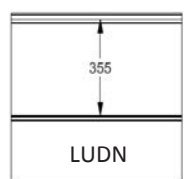
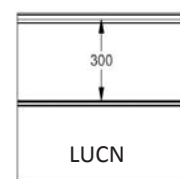
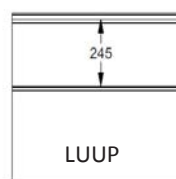
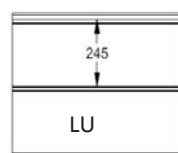

## PRÄGUNG



## FARBE

	9010	9016 P	7016 P	7016 M	8014 P	9006	Goldene Eiche	Dunkel Eiche	PGold	PLight	PDark	PMaha
500	○+	●*	●	○*	○	○+	○	○	○	○	○	○
610	○+	●*	●	○*	○	○+	○	○	○	○	○	○

● = Standard    ○ = Option (mind. 100 m<sup>2</sup>)    ●\* = Nur in glatt    ○+ = Außer in glatt

**EPCO**

YOUR NEEDS. OUR PANELS.

Fingerschutzpaneel mit 8mm microliniierter Außenseite.  
 Erhältlich in den Höhen 500 und 610 mm.  
 Innenseite liniert, stucco-geprägt, RAL 9010.

# PANEEL LM8

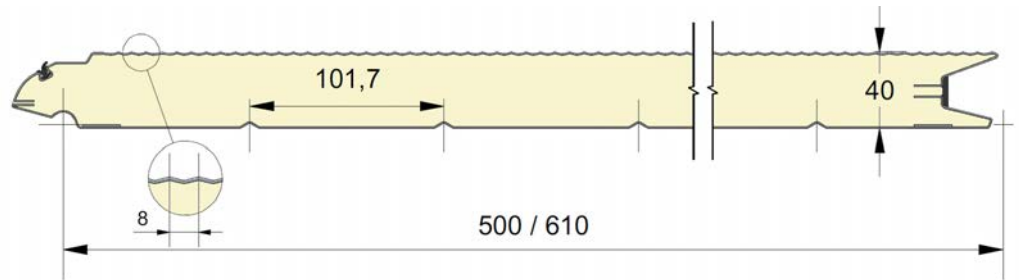

ARTIKELNR.	HÖHE	PRÄGUNG
1619	500	Glatt
1620	610	Glatt

## FARBE

	9016 P	7016 P	7016 M	9006
500	●	●	○	○
610	●	●	○	○

● = Standard    ○ = Option (mind. 100 m<sup>2</sup>)

## PRÄGUNG



# EPCO

YOUR NEEDS. OUR PANELS.

Fingerschutzpaneel mit 16mm V-profilierter Außenseite.  
 Erhältlich in den Höhen 500 und 610 mm.  
 Innenseite liniert, stucco-geprägt, RAL 9010.

# PANEEL LM16

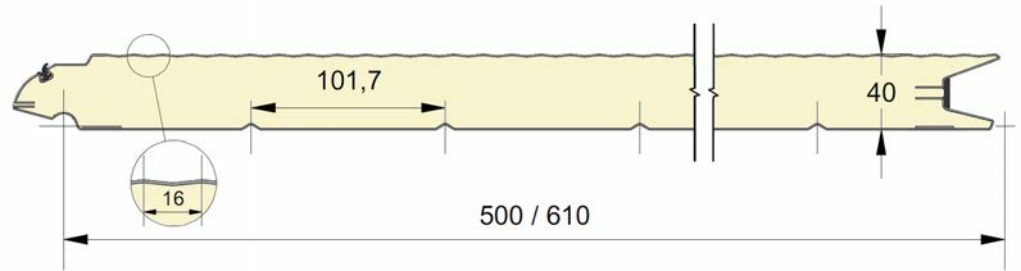

ARTIKELNR.	HÖHE	PRÄGUNG
1649	500	Glatt
1650	610	Glatt

## FARBE

	9016 P	7016 P	7016 M	9006
500	●	●	○	○
610	●	●	○	○

● = Standard    ○ = Option (mind. 100 m<sup>2</sup>)

## PRÄGUNG



# EPCO

YOUR NEEDS. OUR PANELS.

Fingerschutzpaneel, gerillte und 8mm microlinierte Außenseite.  
 Erhältlich in den Höhen 500 und 610 mm.  
 Innenseite liniert, stucco-geprägt, RAL 9010.

# PANEEL LUM8

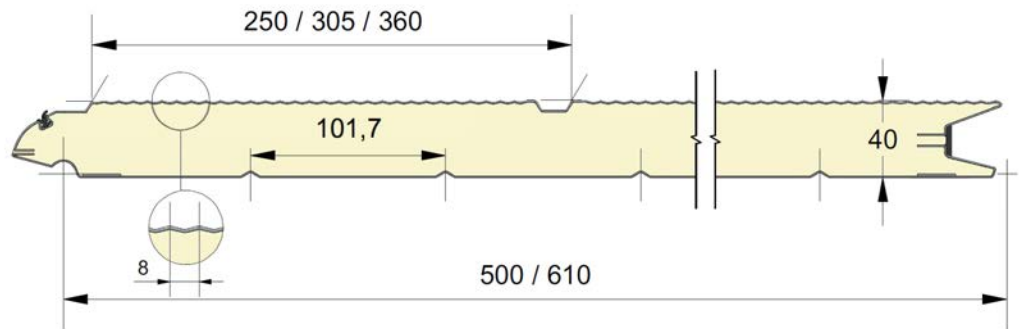

ARTIKELNR.	HÖHE	PRÄGUNG
1621	500	Glatt
1622	610 CN	Glatt
1623	610 UP	Glatt
1624	610 DN	Glatt

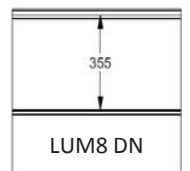
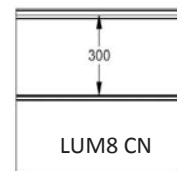
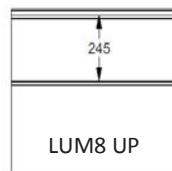
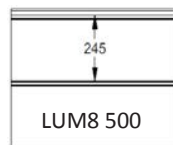

## FARBE

	9016 P	7016 P	7016 M	9006
500	●	●	○	○
610	●	●	○	○

● = Standard    ○ = Option (mind. 100 m<sup>2</sup>)

## PRÄGUNG



**EPCO**

YOUR NEEDS. OUR PANELS.



Fingerschutzpaneel, gerillte und 16mm microlinierte Außenseite.  
 Erhältlich in den Höhen 500 und 610 mm.  
 Innenseite liniert, stucco-geprägt, RAL 9010.

# PANEEL LUM16

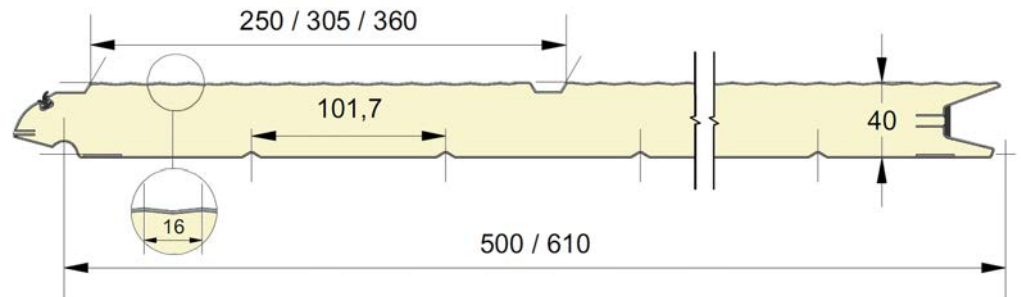

ARTIKELNR.	HÖHE	PRÄGUNG
1651	500	Glatt
1652	610 CN	Glatt
1653	610 UP	Glatt
1654	610 DN	Glatt

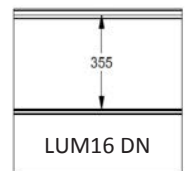
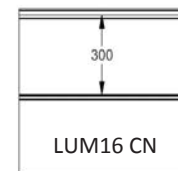
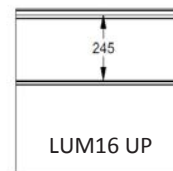
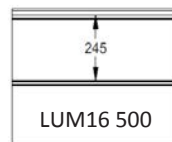

## FARBE

	9016 P	7016 P	7016 M	9006
500	●	●	○	○
610	●	●	○	○

## PRÄGUNG



● = Standard ○ = Option (mind. 100 m<sup>2</sup>)

**EPCO**

YOUR NEEDS. OUR PANELS.

Fingerschutzpaneel mit ubere Rille.  
 Erhältlich in den Höhen 500 und 610 mm.  
 Innenseite liniert, stucco-geprägt, RAL 9010.

# PANEEL LT

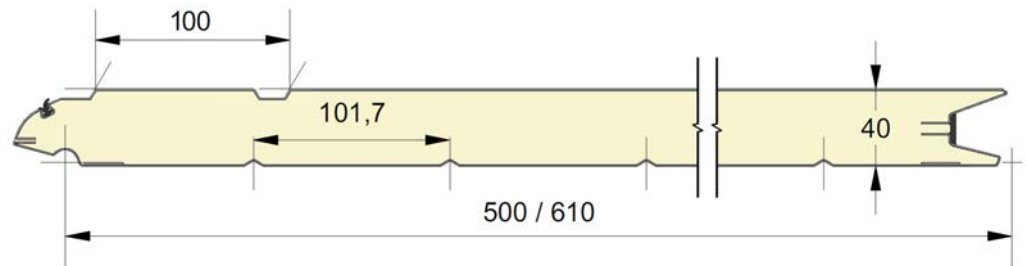

ARTIKELNR.	HÖHE	PRÄGUNG
1677	500	Glatt
1679	610	Glatt
1680	500	Holz
1682	610	Holz
1683	500	Stucco
1685	610	Stucco

## PRÄGUNG



## FARBE

	9010	9016 P	7016 P	7016 M	8014 P	9006	Golden Eiche	Dunkel Eiche	PGold	PLight	PDark	PMaha
500	○+	●*	●	○*	○	○+	○	○	○	○	○	○
610	○+	●*	●	○*	○	○+	○	○	○	○	○	○

● = Standard    ○ = Option (mind. 100 m<sup>2</sup>)    \* = Nur in glatt    + = Außer in glatt

**EPCO**

YOUR NEEDS. OUR PANELS.

20mm Fingerschutzpaneel mit ebener Außenseite.  
 Erhältlich in den Höhen 500 und 555mm.  
 Innenseite liniert, stucco-geprägt, RAL 9010.

# PANEEL CF

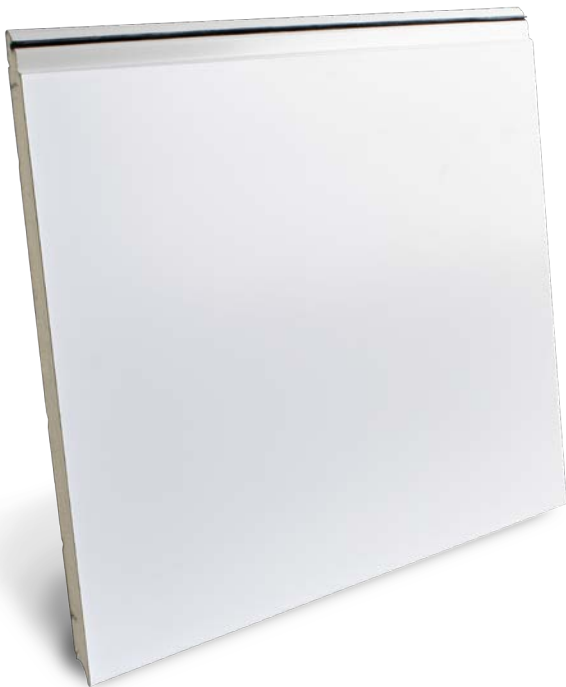
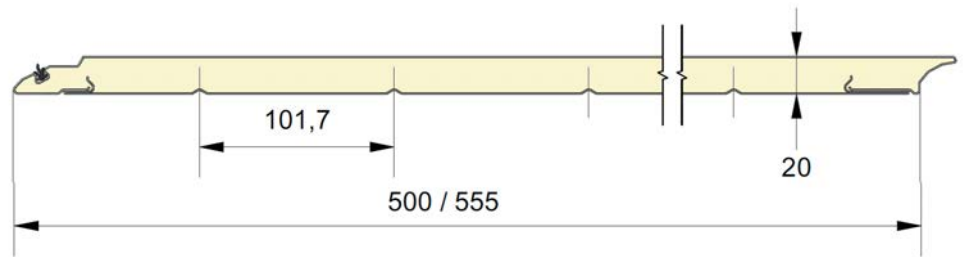

ARTIKELNR.	HÖHE	PRÄGUNG
1801	500	Glatt
1802	555	Glatt
1803	500	Holz
1804	555	Holz
1805	500	Stucco
1806	555	Stucco

## FARBE

	9010	9016 P	7016 P
500	<input type="radio"/> +	<input checked="" type="radio"/> *	<input type="radio"/>
555	<input type="radio"/> +	<input checked="" type="radio"/> *	<input type="radio"/>

## PRÄGUNG



= Standard     = Option (mind. 100 m<sup>2</sup>)    \* = Nur in glatt    + = Außer in glatt

# EPCO

YOUR NEEDS. OUR PANELS.

Fingerschutzpaneel, gerillte Außenseite.  
 Erhältlich in den Höhen 500 und 555 mm.  
 Innenseite liniert, stucco-geprägt, RAL 9010.

# PANEEL CU

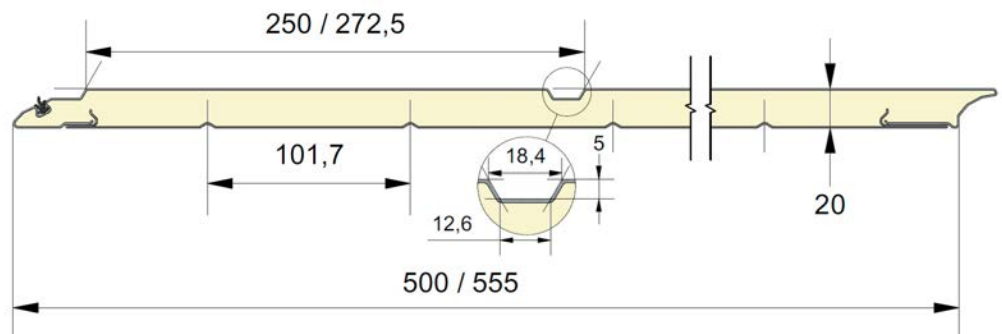

ARTIKELNR.	HÖHE	PRÄGUNG
1807	500	Glatt
1808	555	Glatt
1809	500	Holz
1810	555	Holz
1811	500	Stucco
1812	555	Stucco

## FARBE

	9010	9016 P	7016 P
500	<input type="radio"/> +	<input checked="" type="radio"/> *	<input type="radio"/>
555	<input type="radio"/> +	<input checked="" type="radio"/> *	<input type="radio"/>

## PRÄGUNG



= Standard     = Option (mind. 100 m<sup>2</sup>)    \* = Nur in glatt    + = Außer in glatt

# EPCO

YOUR NEEDS. OUR PANELS.

20 mm Fingerschutzpaneel mit 8mm microliniertes Außenseite.  
 Erhältlich in den Höhen 500 und 555 mm.  
 Innenseite liniert, stucco-geprägt, RAL 9010.

# PANEEL CM8

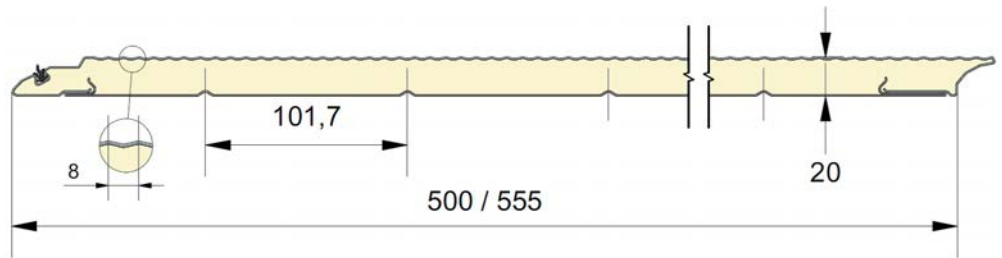

ARTIKELNR.	HÖHE	PRÄGUNG
1813	500	Glatt
1814	555	Glatt

## FARBE

	9016 P	7016 P
500	●	○
555	●	○

● = Standard ○ = Option (mind. 100 m<sup>2</sup>)

## PRÄGUNG



# EPCO

YOUR NEEDS. OUR PANELS.

20 mm Fingerschutzpaneel mit 16mm microlinierter Außenseite.  
 Erhältlich in den Höhen 500 und 555 mm.  
 Innenseite liniert, stucco-geprägt, RAL 9010.

# PANEEL CM16

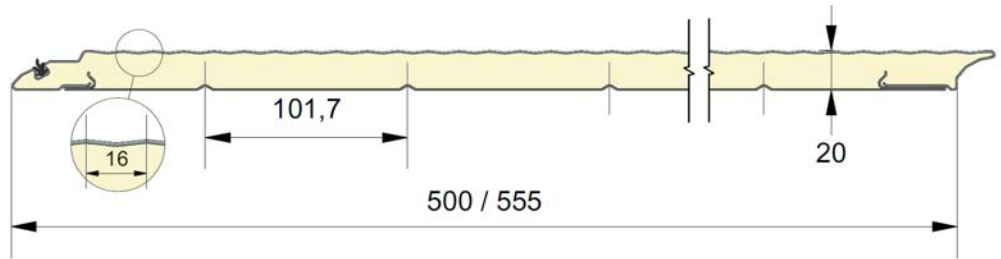

ARTIKELNR.	HÖHE	PRÄGUNG
1815	500	Glatt
1816	555	Glatt

## FARBE

	9016 P	7016 P
500	<input checked="" type="radio"/>	<input type="radio"/>
555	<input checked="" type="radio"/>	<input type="radio"/>

= Standard     = Option (mind. 100 m<sup>2</sup>)

## PRÄGUNG



# EPCO

YOUR NEEDS. OUR PANELS.



20 mm Fingerschutzpaneel, gerillte und 8mm microlinierte Außenseite.  
 Erhältlich in den Höhen 500 und 555 mm.  
 Innenseite liniert, stucco-geprägt, RAL 9010..

# PANEEL CUM8

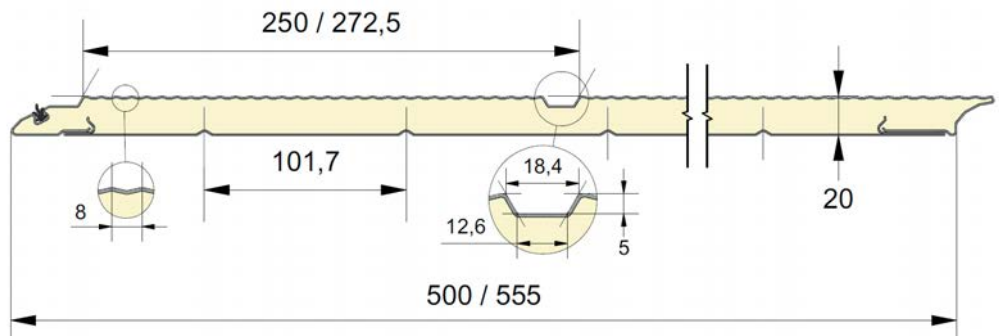

ARTIKELNR.	HÖHE	PRÄGUNG
1817	500	Glatt
1818	555	Glatt

## FARBE

	9016 P	7016 P
500	<input checked="" type="radio"/>	<input type="radio"/>
555	<input checked="" type="radio"/>	<input type="radio"/>

= Standard  = Option (mind. 100 m<sup>2</sup>)

## PRÄGUNG



# EPCO

YOUR NEEDS. OUR PANELS.

20 mm Fingerschutzpaneel, gerillte und 16mm microlinierte Außenseite.  
 Erhältlich in den Höhen 500 und 555 mm.  
 Innenseite liniert, stucco-geprägt, RAL 9010.

# PANEEL CUM16

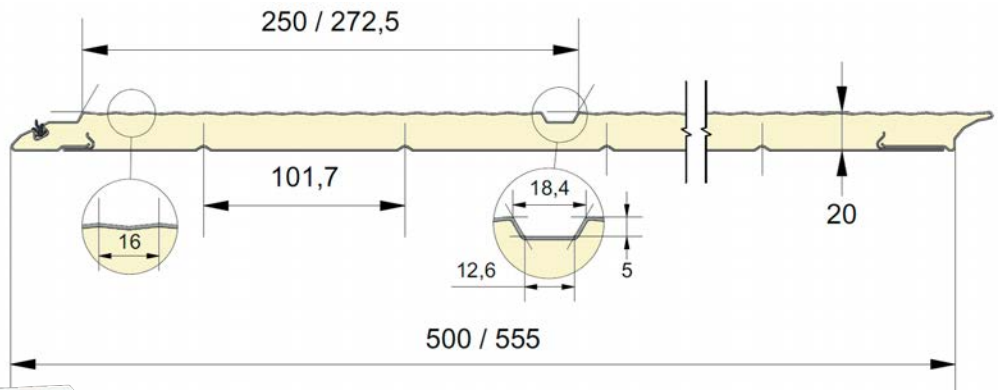

ARTIKELNR.	HÖHE	PRÄGUNG
1819	500	Glatt
1820	555	Glatt

## FARBE

	9016 P	7016 P
500	<input checked="" type="radio"/>	<input type="radio"/>
555	<input checked="" type="radio"/>	<input type="radio"/>

= Standard     = Option (mind. 100 m<sup>2</sup>)

## PRÄGUNG



# EPCO

YOUR NEEDS. OUR PANELS.